

Automatic Guided Vehicles

AGV Comprehensive Catalog

MEIDEN
Quality connecting the next

Irreplaceable Technical Capability



Meidensha AGVs solve the problem!

We will provide the best AGV for you

Meidensha AGVs

Our **technical capability** has been cultivated over our long history. Founded in 1897 as “Meiden Motors” the **motor and control technology** that we have accumulated in over 120 years is irreplaceable. We support motors, control devices and guidance technology, the core technologies at the heart of AGVs.

We have **experience and know-how** from working together with a wide variety of industries that require high-level transportation technology.

We support “monozukuri” in Japan over the years by providing AGVs.

We make full use of our experience as we have continually responded to the harsh operating conditions, frequent line changes, and high demand for reliability.

With an open AGV interface and full line of **system support tools**, we provide AGVs that are easy to use.

AGV Features

Excellent Traveling Control

- Excellent steering control allows our AGVs to smoothly travel even steep curves and gently carry loads with little lateral shaking.
- Without any stationary steering of the drive wheels by powered wheels steering, vehicle height is kept low.

Excellent Guidance Systems

- We provide various guidance systems from traditional magnet guidance systems to the latest multi guidance system so that you can utilize the system best suited to the environment at your site.
- The multi guidance system is a proprietary guidance system that achieves both autonomous travel adopted a SLAM system and a stopping accuracy of ±10 mm.

Excellent User Interface

- AGV travel is controlled according to route data. Created on a PC, route data is configured using over 200 types of commands.
- Using a command mark system, the simple model AGV Kit provides a user interface that allows you to configure a system on your own.

Transport Weight and Applicable AGV Model

We provide the best AGV for your Transport system needs for goods weight from 150 kg to maximum 6000 kg.

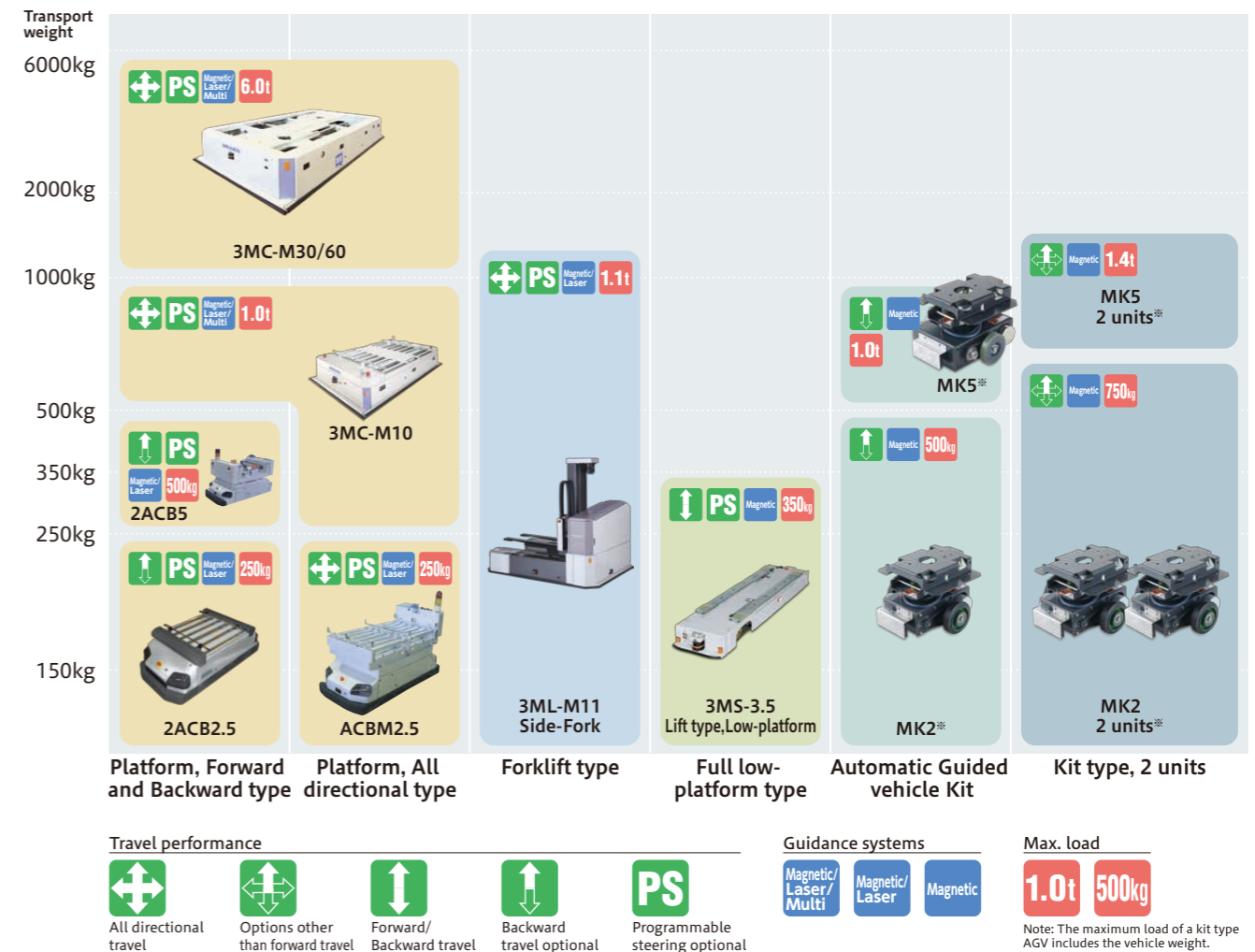

Guidance Systems

We have magnetic, laser, and multi (autonomous travel type) guidance systems. You can select the best guidance system suited to the environment in which the AGV will operate.

Guidance systems	System description	Features	Supported models
<p>Magnetic guidance system</p>	In some cases, a course is created by burying magnetic rods along the course or applying magnetic tape to the floor. The AGV detects the magnetism and follows the guide path.	<ul style="list-style-type: none"> ① The guidance system with the most proven track record. ② Requires burying magnetic rods or laying magnetic tapes. 	<ul style="list-style-type: none"> • Platform type • Forklift type • Low-platform type • All kit type
<p>Laser guidance system</p>	The AGV travels by detecting its position and orientation by using laser radar to scan for reflector installed in the ceiling and walls. This keeps down dust caused by construction because guide wires do not need to be buried.	<ul style="list-style-type: none"> ① Allows creating and changing the traveling route using CAD software running on a PC. ② Does not require laying a guide path. ③ Requires installation of reflectors on the ceiling and walls. 	<ul style="list-style-type: none"> • Platform type • Forklift type
<p>Multi guidance system</p>	The AGV drives autonomously by using a laser range finder to measure the surrounding environment. This system provides high precision positioning by using both magnet and laser guidance.	<ul style="list-style-type: none"> ① Allows the automatic generation of a map and creation of a traveling route on the map using a PC. ② Changing the traveling route using a PC is easy. ③ Perform guide path construction and installation of reflectors in locations that require positioning. 	<ul style="list-style-type: none"> • Platform type of 3MC series

Platform, Forward and Backward type/Platform, All directional type

3MC Series



Stopping accuracy of ± 5 mm! ※3MC-M10
Available to use up to 6 tons!! ※3MC-M60



Features

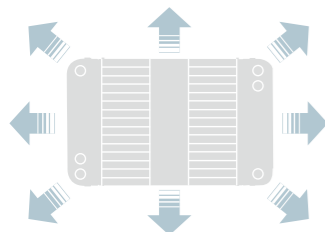

Excellent traveling performance

- Traveling in all directions is possible, such as forward, backward, sideways, slantwise, and spin turn.
- Efficient traveling is possible with a high degree of freedom, making full use of spin turn performance.



Simple operation

- Operation is simple using a touch panel.
- Displays AGV operating status, I/O monitor, and errors.

Specifications

Type	3MC-M10	3MC-M30	3MC-M60
Load capacity	1000kg	3000kg	6000kg
Guidance system	Magnetic rod and Magnetic tape, Laser, and Multi		
Driving, Steering system	Front/Rear wheel drive, Front/Rear wheel steering		
Traveling direction	Forward, Backward, Sideways, Slantwise and Spin turn		
Max. Rated speed	Forward/Backward 60m/min Sideways 30m/min	Forward/Backward 60m/min Sideways 30m/min	Forward/Backward 30m/min Sideways 15m/min
Min. turning radius	730mm		
Stopping accuracy	Forward/Backward ± 5 mm Sideways ± 10 mm		
Vehicle size	W1150×H307/407×D1950mm		
Cargo transfer height	Automatic charging type:307mm, Manual charging type:405mm (cargo transfer unit excluded)	477mm (cargo transfer unit excluded)	
Vehicle weight	600kg		
Voltage	48V enclosed lead-acid battery, Auto-charge type		

Sample applications

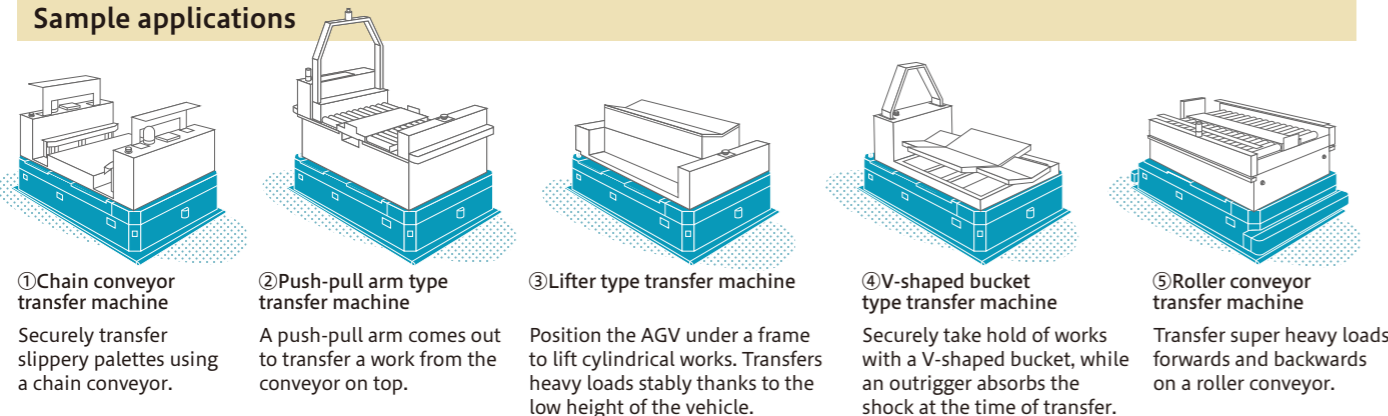

Platform, Forward and Backward type

2ACB



There are product lineups from small to medium types to be chosen according to cargo sizes. This model is most suitable for intra-process transportation in production lines.



Features

- This is a standard AGV of the 3-wheel type vehicle.
- The carrier comes in the roller table (2-serial, 3-serial, and 2-stage type), lifter, and push-pull type, useful in a variety of applications.
- These models support options such as automatic battery charging, destination orders using a wireless LAN, and intersection control.

Specifications

Type	2ACB2.5	2ACB5
Load capacity	250kg	500kg
Guidance system	Magnetic rod and Magnetic tape, Laser	
Driving, Steering system	Front wheel drive, Front wheel steering	
Traveling direction	Forward (Backward: optional) and Spin turn	
Max. Rated speed	60m/min	
Vehicle size	W685×H340×D1600mm	W800×H350×D1750mm

Sample applications

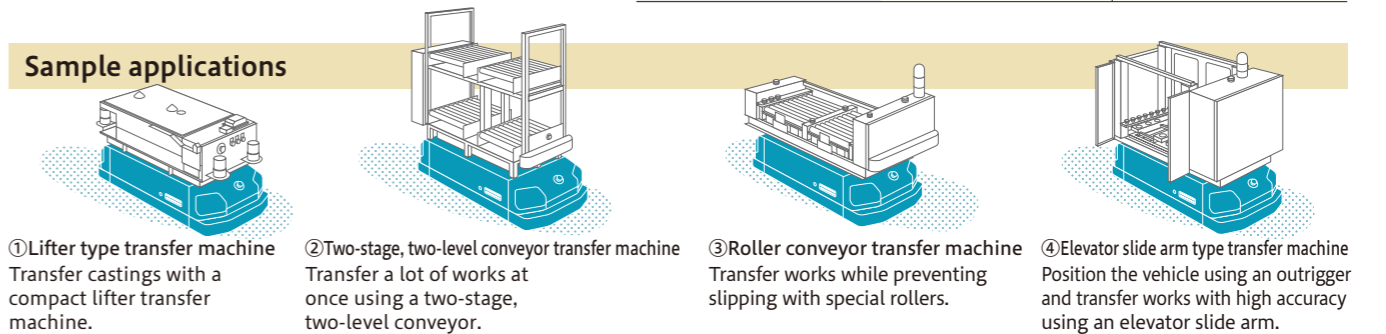

Platform, All directional type

ACBM All directional type



Most suitable for transportation in a narrow space.

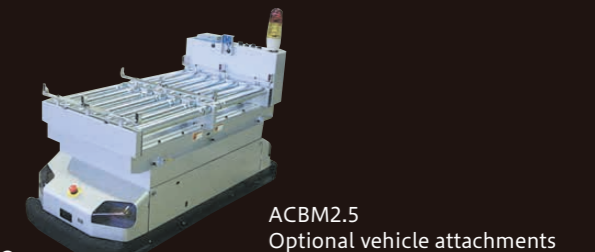

Features

- This AGV is of the Front/Rear wheel driving and steering type.
- Traveling forward/backward, traverse slantwise, and spin turn is possible.
- Traveling is possible in a narrow space.
- Because it is possible to be moved to all direction, the cycle time can be shortened.

Specifications

Type	ACBM2.5
Load capacity	250kg
Guidance system	Magnetic rod and Magnetic tape, Laser
Driving, Steering system	Front/Rear wheel driving and Steering type
Traveling direction	All direction and Spin turn
Max. Rated speed	60m/min
Vehicle size	W755×H360×D1600mm

Sample applications

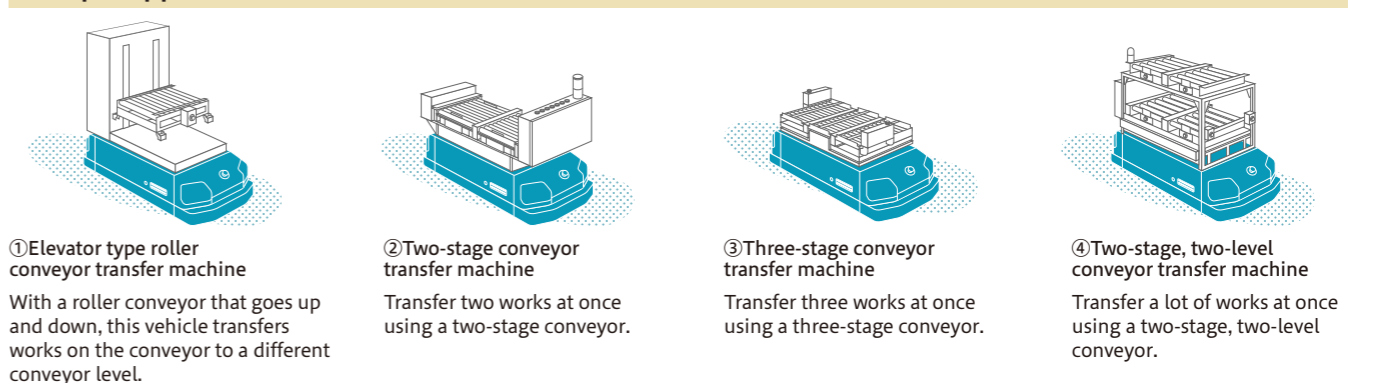

Forklift type

Side-Fork Type Pallet Transport AGV



AGV especially for conveying pallets.



Full flat low-platform type

Lift type Low-platform AGV



This Lift type low-platform AGV is suitable to customers who do not want to modify their existing carts.



Features

- Even along a passage of 2400mm in width, it is possible to gain access to the destination without changing the posture.
- A 180° spin-turn is possible in a passage of 3000mm in width.
- Since the brushless motor is adopted for the driving unit, properties of cleanliness and maintainability have been improved.
- Every direction has obstacle sensor and bumpers in order to secure high safety.

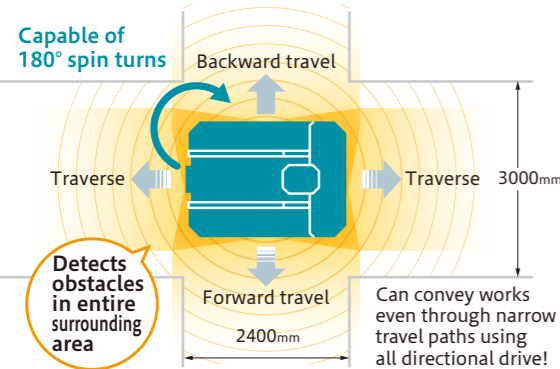

Specifications

Type	3ML-M11
Load capacity	1100kg (Cargo center 600mm, deviation from the center of gravity ±50mm)
Guidance system	Magnetic rod and Magnetic tape, Laser
Driving, Steering system	Front/Rear wheel driving and Steering type
Traveling direction	Forward/Backward Sideways, and Spin turn
Max. Rated speed	60m/min (Sideways 30m/min)
Max. Elevating height	1000mm, or 1800mm for optional
Max. Elevating speed	250mm/sec
Reach stroke	1350mm
Reach speed	250mm/sec
Min. turning radius	1500mm (Forward/Backward 15m/min)
Stopping accuracy	Vehicle base end ±10mm, Fork end ±30mm
Transport pallet size	Max. 1200×1200mm
Vehicle size	W2278×L1748×H1738mm
Vehicle weight	2050kg
Voltage	Automatic battery charging system 48V 150Ah

Description of operation

- ① The AGV houses a fork.
- ② After traveling and stopping, the AGV extends the fork into the palette.
- ③ The fork lifts the palette and pulls it onto the AGV.
- ④ After loading the item to be conveyed onto the AGV, the vehicle starts traveling.

Safe design!

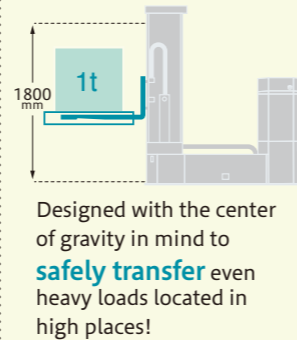
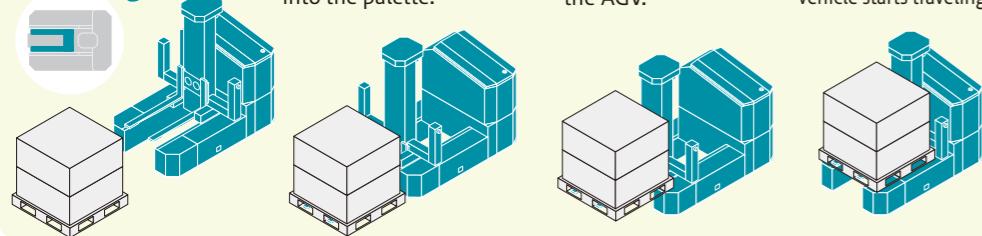

Sample applications

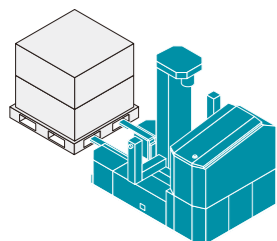

When the item to be conveyed is located on the floor.

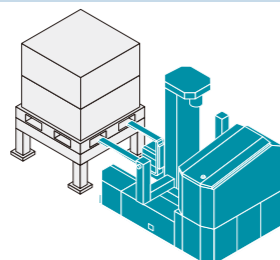

When the item to be conveyed is located on a frame.

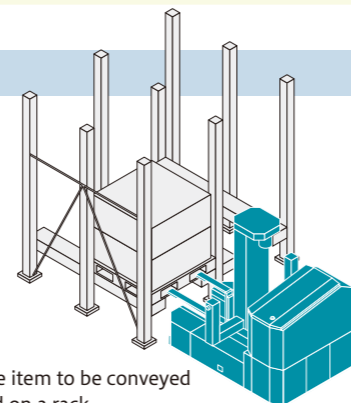

When the item to be conveyed is located on a rack.

Description of operation

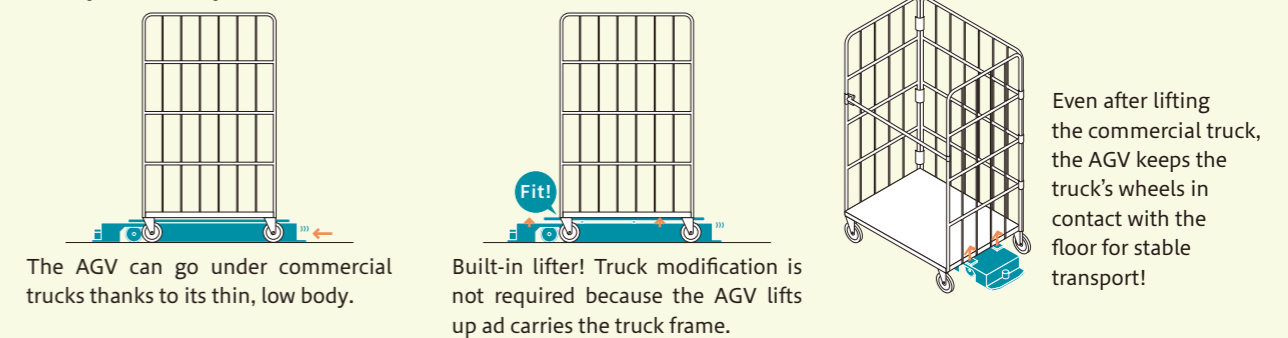

Sample applications

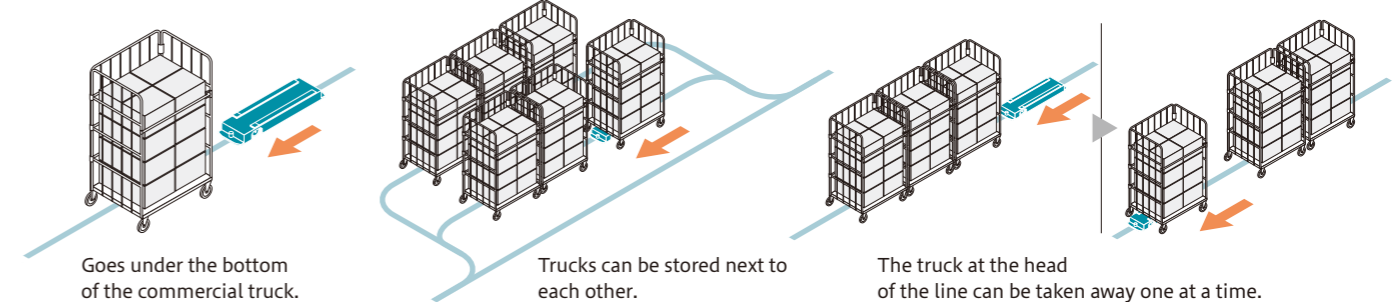

Automatic Guided Vehicle Kit

Meiden AGV Kit MK2/5 Series



Wouldn't you like to have such an AGV? Anyone can use it. This is an open interface AGV that permits easy system structuring.

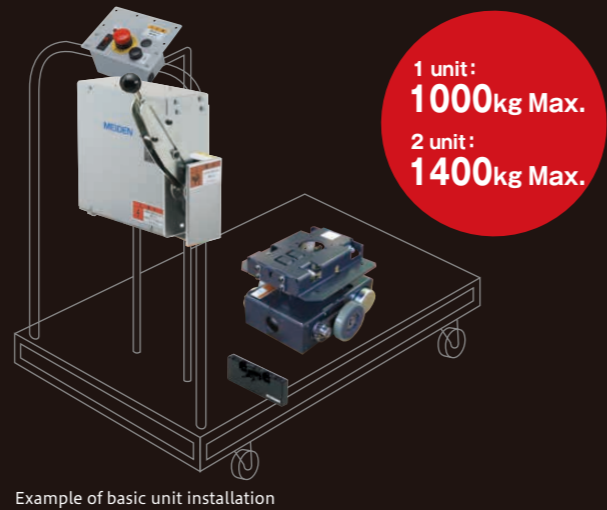

Example of basic unit installation

1 unit:
1000kg Max.
2 unit:
1400kg Max.

Basic unit

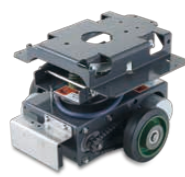

Light-weight drive unit



Heavy-weight drive unit



Control unit



Operating switch

Simple how to use !

- The AGV offered meets arbitrary requirements, from a basic unit to a completed vehicle.
- Start/Stop operation is simple with a single button.
- Since an external I/O circuit is released to be open, any customer can establish a favorite system.

Flexible interaction possible with layout change !

- Stick a magnetic tape to the floor surface-That's all. By taking such an easy action, a traveling route can be easily set up.
- When markers are installed on the floor, operation control for acceleration and deceleration can be accomplished easily.
- Using a simplified backward traveling function, various running routes can be established.

Expansibility that is attractive !

- A wireless controller option can be used to provide call in control, dispatch control and standby control.
- There are two control systems available according to applications.

Command mark system : Command markers are stuck to the floor for simple control.

Relative address system : Operation is programmed for each mark on the floor for complicated operation control.

Setting of options

- Battery
- Battery charger
- Battery voltmeter
- Setter on vehicle (A/2B type)
- Laminate pilot lamp
- Auto-charger
- Wireless controller
- Simple backward function
- Tape bumper
- Obstacle sensor
- Traveling melody unit
- Magnetic tape marker
- Urethane tire
- Manual operation pendant
- Magnetic brake
- Traversing and spin turn function

Specifications

		Light-duty class (MK2)			Heavy-duty class (MK5)		
		Standard type	High-speed type	Heavy load type	High-speed type	Heavy load type	
Permissible load ^{※1} (total weight)	1 Unit - Advance	250kg	250kg	500kg	500kg	1000kg	
	2Units	Forward/Backward travel	350kg	350kg	700kg	700kg	1400kg
		Traverse ^{※2}	350kg	350kg	700kg	700kg	1400kg
		Spin turn ^{※2}	175kg	175kg	350kg	350kg	700kg
Rated speed ^{※3,4,5}		30m/min	60m/min	30m/min	60m/min	30m/min	
Guidance system		Magnetic tape					
Traveling direction		Forward (Backward for optional)					
Stopping accuracy ^{※6}		Standard ±30mm (±15mm for optional)			Standard ±15mm		
Gradability (5m continuous)		2% (at the rated load), 3% (at 70% load)					
Voltage		DC24V					
Environment ^{※7}		Temperature 0-40°C, Relative humidity 20-80% Road surface step differences within 6mm (at 15m/min speed), Road surface undulations within 10mm, Groove width not more than 20mm					

※Note 1. The allowable load includes vehicle. The allowable weight also varies depending on the traveling resistance of caster wheels.

※Note 2. The allowable load given for lateral travel and spin turning is for when solid elastomer is used for the caster wheel material.

※Note 3. When the AGV is fully charged and moving a standard empty frame

※Note 4. Maximum speed during traverse or spin turning is 15 m/min. ※Note 5. Maximum speed during simple backward travel is 20 m/min.

※Note 6. The stopping accuracy for lateral travel and spin turning is ±30 mm. ※Note 7. Lateral travel and spin turning should be done on a non-sloping surface.

Standard Carts with an AGV Kit

Assembled carts with AGV Kit



Assembled carts equipped with an AGV Kit are also available.

Sheet metal cart

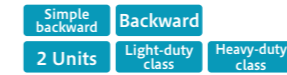

- In the nished-cart line-up, only this model can be equipped with all the specifications and options.

Cart external dimensions/W700×H1320×L1250mm
Platform-section dimensions/W700×H240×L950mm

Handcart



- Can be used immediately as a replacement for your current handcart.
- Intended for customers that want an easy start to use.

Cart external dimensions/
W620×H1015×L942mm
Platform-section dimensions/
W620×H265×L785mm

Pipe cart



- The body of this model can be modified daily.

Cart external dimensions/W700×H1320×L1250mm
Platform-section dimensions/W700×H345×L945mm

Flat cart



- This low-platform model is compact.

Cart external dimensions/W500×H350×L1232mm
Platform-section dimensions/W500×H350×L1000mm

[Practical Assembly] With the AGV Kit you can create an AGV suited to the items to be carried

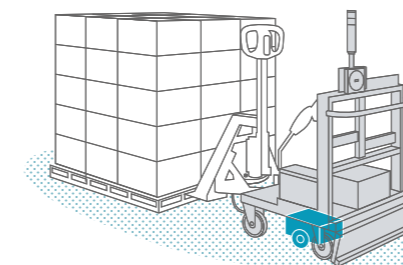

Hand pallet towing truck

You can attach a hand pallet behind a truck equipped with an AGV Kit and tow it. Once detached, it can be used as an ordinary hand pallet.

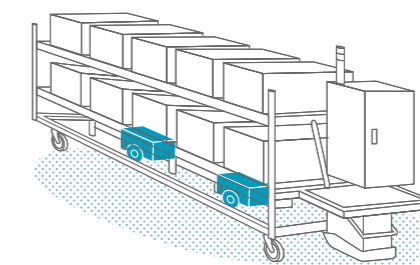

Truck for conveying a picking box

Supply collected parts to a line using a digital picking system. Many parts can be transported at a time.

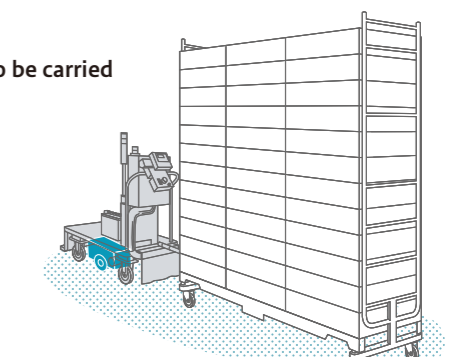

Cart towing truck

The AGV Kit can tow carts on which products are placed from where they come in to where they are stored.

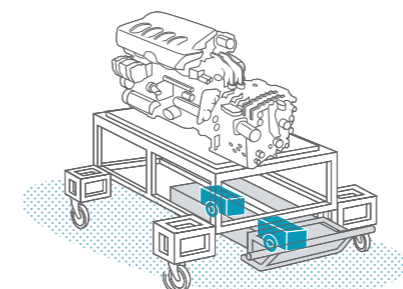

Truck for conveying heavy items

When two drive units are attached, loads up to 1400 kg can be conveyed. Convey loads by placing a truck with installed AGV Kit under a truck already being used (up to 1,000 kg per drive unit).

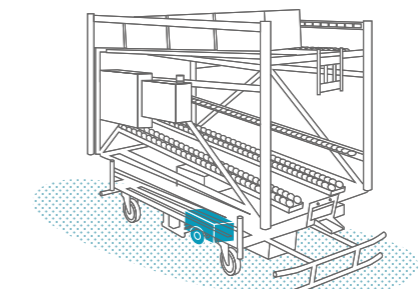

Conveyor truck with inclined conveyor

Allows you to take down heavy loads easily. Also serves to reduce costs because a driven conveyor is not needed.

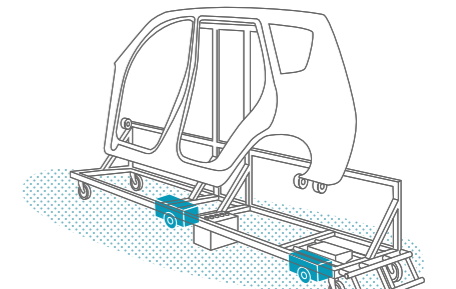

Truck for conveying long items

You can also convey long items by attaching two drive units. Allows stable travel because the two independent drive units travel on a guide path.

Dimensions

unit(mm)

Standard AGV

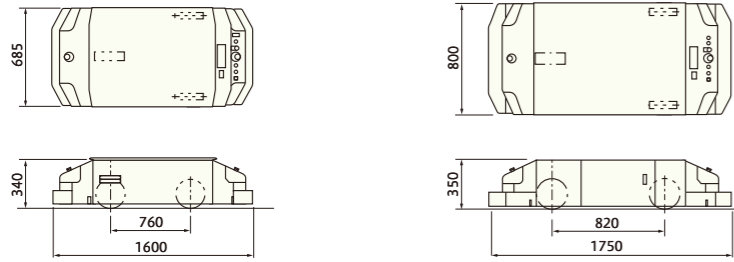

All directional AGV

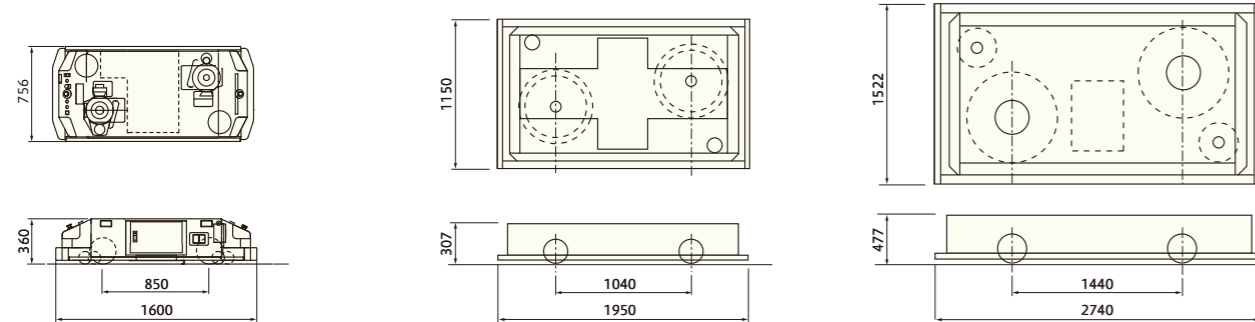

Lift type Low-platform AGV

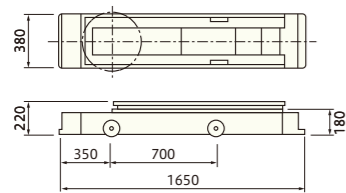

Side-Fork

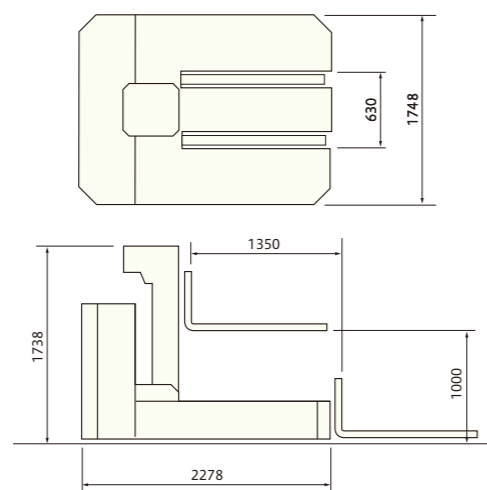

Side-Fork loading data

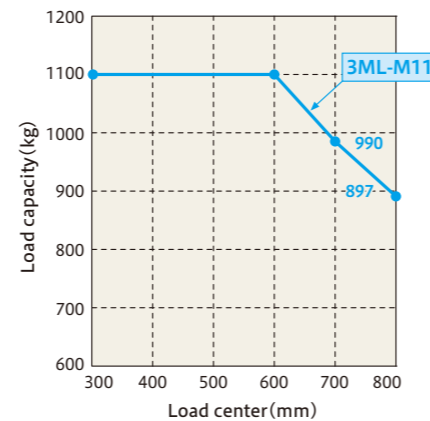

● Since the above data are based on calculations, a margin of more than 10% should be taken into account.

Option

Automatic Battery Charge

Features:

- Around-the-clock continuous operation is possible with a feature of automatic battery charging.
- Charging is performed after confirming the stop position of AGV.



Wireless LAN unit

Features:

- Using a wireless LAN unit, high-speed communication with a ground station can be carried out.
- Wireless Standard IEEE802, 11b/g/n 2.4GHz
- Used for the destination order or call in control.



Specifications

Items	Platform, Forward and Backward type		Platform, All directional type			Forklift type	Full flat Low-platform type		
	2ACB2.5	2ACB5	3MC-M10	3MC-M30/60	ACBM2.5	3ML-M11	3MS-3.5		
Load capacity (including transfer unit)	kg	250 (400)	500 (750)	1000 (1500)	3000/6000	250 (400)	1100	350	
Guidance system	Magnetic rod / Magnetic tapes / Laser		Magnetic rod / Magnetic tapes/Laser/ Multi		Magnetic rod / Magnetic tapes / Laser	Magnetic rod / Magnetic tapes / Laser	Magnetic rod / Magnetic tapes /		
Driving, Steering system	Front wheel driving, Front wheel steering		Front/Rear wheel driving, Steering			Front/ Rear wheel driving, Steering	Front wheel driving, Front wheel steering		
Traveling direction	Backward	Optional		○			○	○	
	All directional	—		○			○	—	
	Spin turn	—		○			○	—	
Rated speed	m/min	60		Forward/Backward 60 Traverse 30 (3MC-M60 Forward/Backward 30 Traverse 15)			Forward/ Backward 60 Traverse 30	Forward 60 Backward 30	
Elevating speed	mm/s	—		—			250	—	
Reach speed	mm/s	—		—			250	—	
Minimum turning radius	mm	850	900	730	1200	1000	1500	800	
Stopping accuracy (Speed before stop: 8m/min)	mm	±10		±5	±10		Machine base end ±10 Fork end ±30	±10	
Gradiency (5m continuous)	%	—		2			—	—	
Standard working time	h	8		8			8	Continuous (auto-charge only)	
Major dimensions	Length/ () Spec. for backward	mm	1550 (1600)	1655 (1750)	1950	2740	1600	1748	1650
	Width	mm	685	800	1150	1522	756	2278	380
	Height	mm	340	350	307 (Automatic charging type) 407 (Manual charge type)	477	360	1738	180
	Load-carrying platform height	mm	340	350	307 (Automatic charging type) 407 (Manual charge type)	477	360	35~1035	180
	Minimum ground height	mm	25	30	30			35	20
	Weight	kg	220	360	600	1550	290	2050	150
Storage batteries	Type	Open type lead batteries for battery replacement system, Enclosed type lead batteries for auto-charge system							
	Voltage	V	24	48	48		24	48	24
Automatic battery charge type	Optional		○			○			
Wireless LAN	Optional								

Note. Road surface where AGV cannot be used:

- Water and oil are prevalent.
- Inclination is 2% or more.
- Road surface heavily contaminated
- Asphalt-covered road surface
- Path surfaces where level differences, grooves and warps exceed specified values.
- Magnetically active path surfaces such as steel floors (when using magnetic guidance)



MEIDENSHA CORPORATION

ThinkPark Tower, 2-1-1, Osaki, Shinagawa-ku, Tokyo, 141-6029 Japan

www.meidensha.com

Overseas Offices & Group Companies

China

MEIDEN ZHENGZHOU ELECTRIC CO., LTD.
MEIDENSHA (SHANGHAI) CORPORATE MANAGEMENT CO., LTD.
MEIDEN HANGZHOU DRIVE SYSTEMS CO., LTD.
SHANGHAI MEIDENSHA CHANGCHENG SWITCHGEAR CO., LTD.

Hong Kong

MEIDEN PACIFIC (CHINA) LTD.

India

MEIDEN INDIA PVT. LTD.
PRIME MEIDEN LTD.

Indonesia

P.T. MEIDEN ENGINEERING INDONESIA

Korea

MEIDEN KOREA CO., LTD.

Malaysia

MEIDEN MALAYSIA SDN. BHD.
MEIDEN METAL ENGINEERING SDN. BHD.

Singapore

MEIDEN ASIA PTE. LTD.
MEIDEN SINGAPORE PTE. LTD.

Thailand

THAI MEIDENSHA CO., LTD.
MEIDEN ELECTRIC (THAILAND) LTD.

United Arab Emirates

MEIDEN ASIA PTE. LTD. DUBAI BRANCH

Germany

MEIDEN EUROPE GmbH.
TRIDELTA MEIDENSHA GmbH.

The United States

MEIDEN AMERICA, INC.
MEIDEN TECHNICAL CENTER NORTH AMERICA LLC