

# Meiden Variable Speed Drive Systems

**Our Cutting-Edge Technologies Foresee the Global Environment in the Future**



THYFREC VT240S



THYFREC VT730S / VT710



GORIKI Series PMD410



THYFREC VT630



THYFREC VT630MS



THYFREC VT800



THYFREC VT240EL



THYFREC CV700SB



THYFREC VT310



THYL 300C



THYFREC CV240S



THYFREC VT850H

*Power  
&  
Flexibility*

# High Potential Motor Drive Series

## Product Lineups Meeting the Needs of our Customers

Since Meidensha sent out its first inverter to the Japanese market, Meiden inverters have been favorably accepted by many users for a long time. The Meiden variable speed drive system is the trademark product of Meidensha, stemming from its inverter technologies.

The company's products meet a variety of requirements of our customers in terms of high performance, high quality, labor saving, and energy conservation through the fusion of cutting-edge technologies and abundance of technical capabilities. Meidensha offers variable speed drive systems for low and high-voltage motors from general-purpose to exclusive use, and continues to supply products as it foresees the future global market.

## Contents



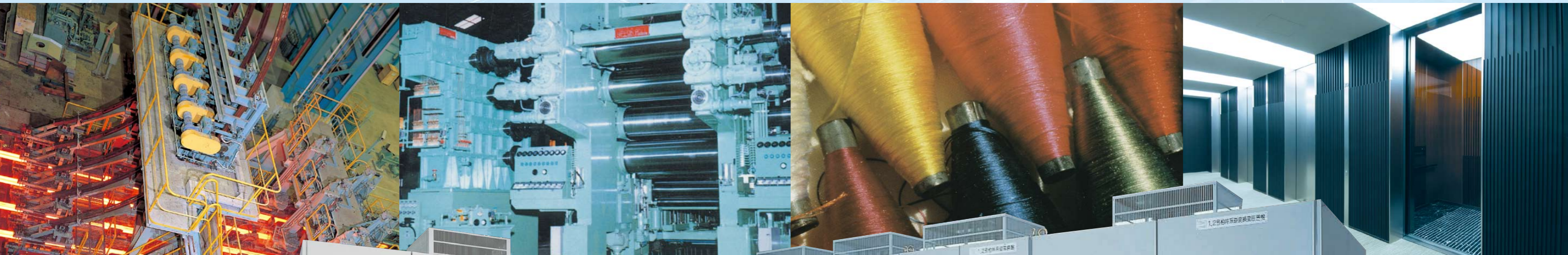



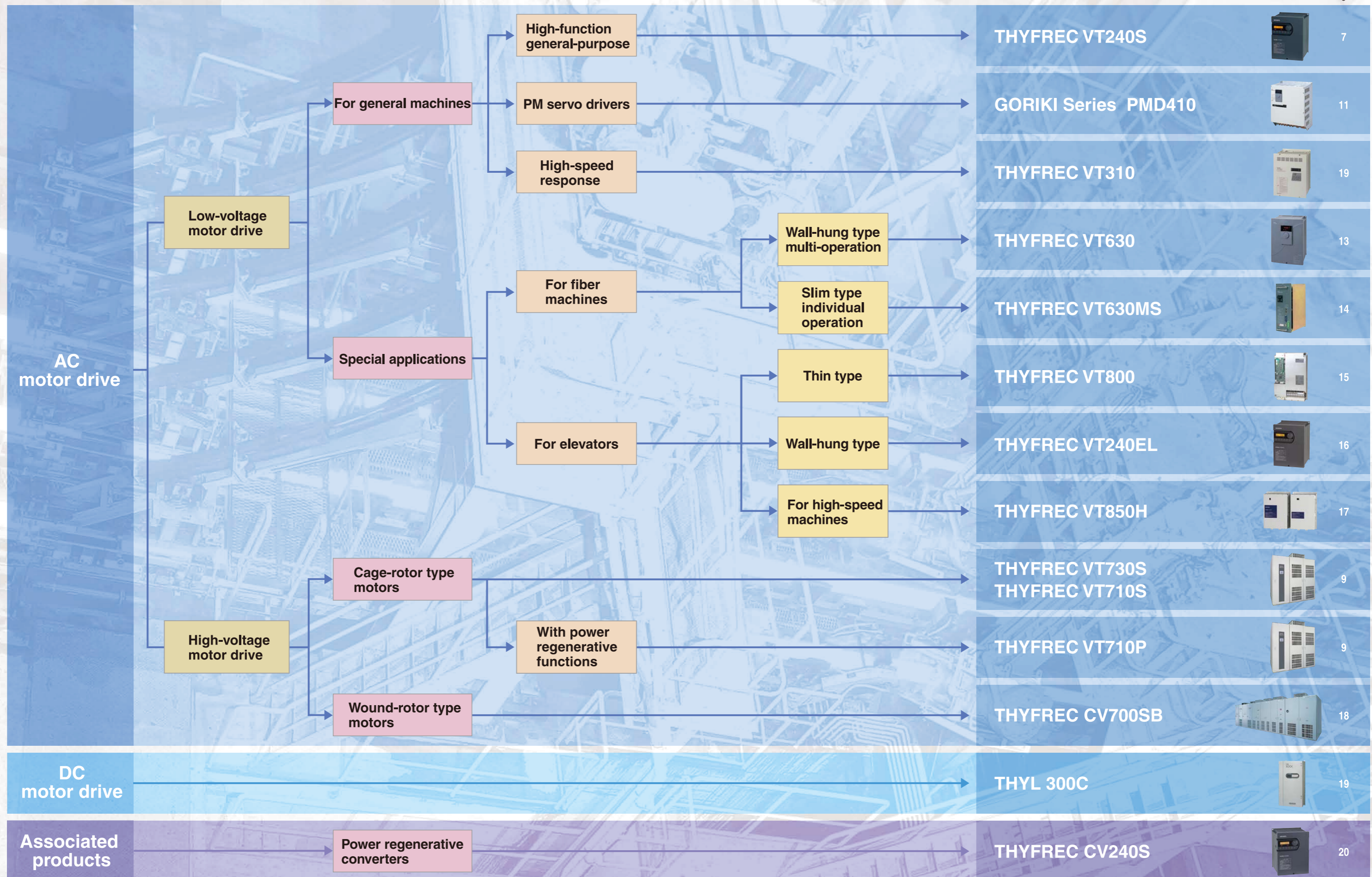

List of products	Product lineups	3
	List of specifications / Table for product selection	5
	THYFREC VT240S	7
	THYFREC VT730S/VT710	9
Variable speed units	GORIKI Series PMD410	11
	THYFREC VT630	13
	THYFREC VT630MS	14
	THYFREC VT800	15
	THYFREC VT240EL	16
	THYFREC VT850H	17
	THYFREC CV700SB	18
Associated products for inverters	THYFREC VT310 THYL 300C	19
	THYFREC CV240S	20
	Other products	21
	List of controls and functions	23
	Lifecycle engineering	24

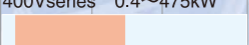

## Line up

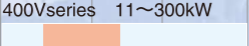

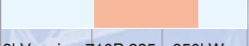
## List of products and specifications

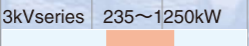
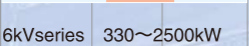
				Applicable output range		Power source	Output frequency range	Overload durability	Acceleration, deceleration	Transmission function	Installation system	Operating environment			Page
				0	10							100	1000	4000 kW	
Low voltage	General-purpose	THYFREC VT240S		200V series 0.4~90kW 	400V series 0.4~475kW 	200/400V series 50 or 60Hz	0.1~440Hz	120%, 1minute 150%, 1minute	0.01~60,000sec.	PROFIBUS-DP CANopen DeviceNet CC-Link I/O link II metal	Wall-hung type	-10~50°C	95% or below	Altitude: 1000m or below Indoors	7
	Servo	GORIKI		200V series 3.7~75kW 	400V series 11~300kW 	200/400V series 50 or 60Hz	750~2000min <sup>-1</sup> (Rated rpm)	Dependent on coupling with the motor	0~300sec.	—	Wall-hung type	-10~50°C	95% or below	Altitude: 1000m or below Indoors	11
High voltage	Direct high voltage	THYFREC VT710S/P		3kV series 710S 110~1800kW 	3kV series 710P 235~950kW 	3/6kV series 50 or 60Hz	0.1~120Hz	120%, 1minute 150%, 1minute	0.01~60,000sec.	Ethernet PROFIBUS-DP I/O link II metal I/O link II optical RS-422/485	Self-standing type	0~40°C	85% or below	Altitude: 1000m or below Indoors	9
	Direct high voltage	THYFREC VT730S		3kV series 235~1250kW 	6kV series 330~2500kW 	3/6kV series 50 or 60Hz	0.1~120Hz	120%, 1minute 150%, 1minute	0.01~60,000sec.	Ethernet PROFIBUS-DP I/O link II metal I/O link II optical RS-422/485	Self-standing type	0~40°C	85% or below	Altitude: 1000m or below Indoors	9

## Table of inverter selection for respective applications

			Fluid-related machines				General machines								Cargo handling machines			Fiber and others		
			Pumps	Fans and blowers	Descaling pumps	Roots blowers	Extruders	Wire drawing machines	Centrifugal separators	Bumbary mixers	Printing machines	Winding machines	Agitators	Injection molding machines	Food machines	Semiconductor units	Belt conveyors	Cranes	Carrier tables	Fiber spinning machines
Low voltage	General-purpose	THYFREC VT240S	○	○	○	○	○	○	○	○	○	○	○	○	○	○	○	○	○	○
	Servo	GORIKI					○		○		○			○			○			
High voltage	Direct high voltage	THYFREC VT730S/710S	○	○	○	○	○					○				○	○			
		THYFREC VT710P															○			○



# THYFREC VT240S



## Next-generation global general-purpose inverters further evolved with a variety of new functions

- A variety of applications with only one unit.
- Friendly to peripheral equipment and friendly to the global environment (and of course, economical performance by energy-saving operation).
- Conformance to international standards; outstanding features enabling display in 5 languages.

### Control modes

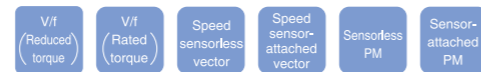

### Functions



### Specifications

Applicable motor	0.4~475kW
Max. rated continuous current	200V system : 5.0~328A 400V system : 2.5~870A
Overload durability	120% 1 min., 150% 1 min.

## Examples of applications:

A single all-in-one unit is used for a variety of applications:

This inverter unit has six control modes covering a variety of applications from an energy-saving operation of fans and motors to high-precision and high-response operation in iron and steel processing lines.

### Six control modes installed:

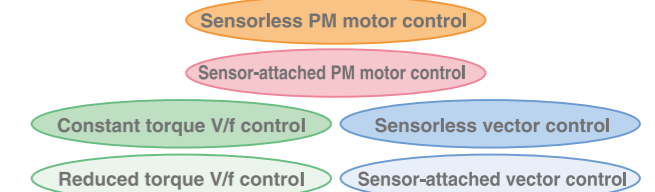

### Conveyors



### Pumps



### Continuous forging facilities

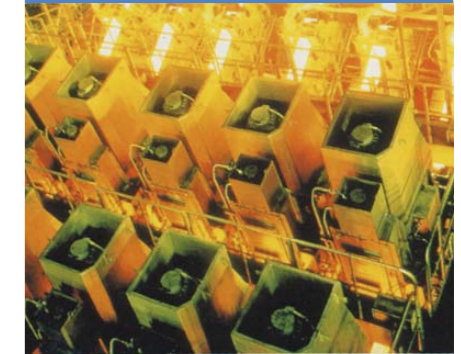

## Major features:

### All-in-one

Six control modes are available. This is an all-in-one inverter, which performs six (6) functions with only one (1) unit. Induction motors and PM motors can be driven; they are free from motor selection.



### Intelligent

The sequencer functions are available for free programming with a variety of exclusive applications such as a PID control and multi-pump control. Used for various applications.



### Friendly to the environment

This type of inverter is designed to cope with environmental conditions with the features of a built-in noise filter, DC reactor, and compliance with European environmental specifications RoHS directive. Motor noise is reduced due to soft-sound functions.



### Global

A multi-language LCD operation panel is adopted, conforming to international standards (UL, cUL, CE mark). Global application is possible with a wide voltage range.



### Cranes



### Calender lines

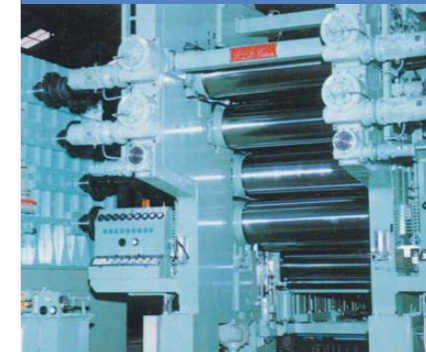

### Fans & blowers

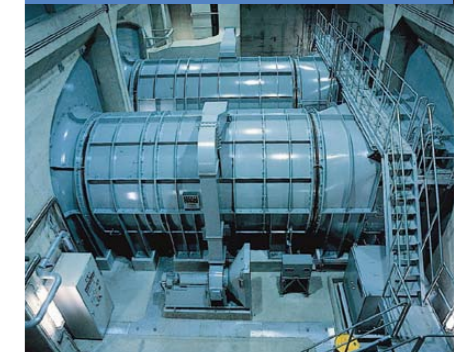

### Point 1

Using six control modes, the VT240S is applicable to various kinds of machines. It permits the common use of spare parts and operation with the same user-friendliness. We have received high evaluations from people working in the design and maintenance sectors.

### Point 2

When combined with a Meiden PM motor, efficiency and power factor can be substantially improved. Requirements of high-efficiency motors can be met throughout the output range stipulated in the JISC4212 (2000) Standard.

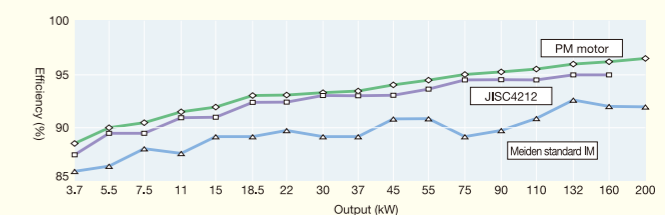

# THYFREC VT730S/VT710

## THYFREC VT730S/VT710



### The last resort for energy saving! Speed control for high-voltage motors

- New VT730S Series conforms to overseas standards.
- Attainment of high efficiency (97%) and high power factor (0.95).
- Overall sizes are the smallest in this business field; versatile use of installation space.
- Regeneration type series (VT710P) available in addition to standard types (VT710, VT710S, VT730S).

#### Control mode

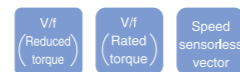

#### Functions

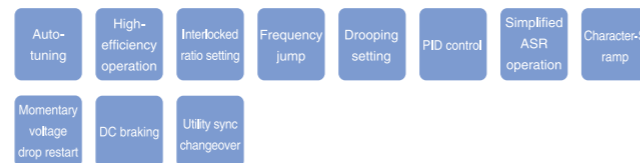

Specifications	VT710 VT710S	VT710P (with power regenerative function)	VT730S (applicable to overseas standards)
Applicable motor	110~3750kW	235~2000kW	235~2500kW
Max. rated continuous current	3kV system : 26~400A 6kV system : 13~400A	3kV system : 55~213A 6kV system : 55~213A	3kV system : 58~266A 6kV system : 39~266A
Overload durability	120% 1 min., 150% 1 min.	120% 1 min., 150% 1 min.	120% 1 min., 150% 1 min.

### Major features:

#### High efficiency and high power factor

Since the direct high voltage system is adopted, the inverter's combined efficiency has attained 97%! Source power factor is maintained at 0.95, which means that no power factor improving device is needed. Even with a light load, high efficiency is maintained which contributes to the function of high-efficiency operation.

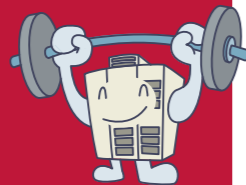

#### Provision of power regenerative functions (VT710P)

During the deceleration of a motor, rapid deceleration can be performed by generating a brake torque. This feature has extended the application range. In addition, the regenerative energy generated during rapid deceleration can be fed back to the power source side. As a result, extreme energy saving can be attained.

#### Friendly to peripheral equipment and motors

The multi-phase rectification system decreases influence upon peripheral equipment because the harmonics in the power source are remarkably reduced. Meidensha's unique system suppresses generation of surge voltages that adversely impacts motors. Therefore, existing standard motors can be immediately combined with inverters.

#### Conformance to overseas standards (VT730S)

Standard models are applicable to overseas standards (IEC61800 Series).

#### Reduction of harmonics

For 6kV systems of VT730S, harmonics are remarkably reduced with the aid of a 36-phase rectification.

### Examples of applications:

#### Fans and pumps

Formerly used for fans, pumps, and such fluid-handling machines, motors were operated at a constant speed on a utility power system and the flow rate and pressure were controlled with the use of regulating valves (dampers). Since the revolving speed is constant, however, power consumption is not reduced effectively even though the flow rate is lowered with a damper.

On the other hand, if the motor speed is controlled with inverters, operating power is reduced almost in proportion to the revolving speed raised to the third power; therefore a greater effect of power saving can be acquired. Furthermore, if the regeneration type (VT710P) is adopted, a fan or a blower with a large inertia can be stopped in a short amount of time.

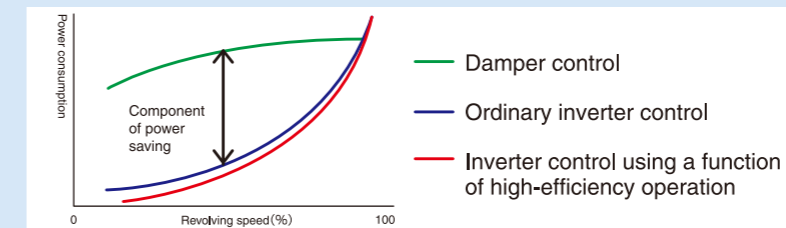

Refuse disposal facility

#### Large-scale crane

A crane requires a brake torque at the time of deceleration and cargo lowering. Its intensity is increased as the cargo becomes heavier. Since the crane motor functions as a generator at that time, regenerative energy is generated in proportion to the intensity of the brake torque. Since the power regenerative type of VT710P can return this regenerative energy to the power source, it is most suitable for a crane that performs rapid deceleration. Also for an extended time of cargo lowering, further energy saving can be expected because regenerative operation is possible. If a vector control is used with speed sensors, inching operation with high-response performance can be performed.



In addition to the above, inverters can be used in many cases.

### Q & A

#### Q. What is a direct high voltage type of inverter?

A: Conventional high voltage inverters were once called the "step-up" system. In this system, the output circuits of multiple low-voltage inverter units are connected to the primary circuit of a step-up transformer so that the high voltage of the transformer can be connected to the motor. The "direct high voltage" system makes multiple low-voltage inverters connect in a series so that a high voltage is gained without the use of any step-up transformer. Since no step-up transformer is used, higher efficiency, increased space-saving, and cost reduction can be expected compared with the step-up system. The inverter where this direct high voltage system is adopted is called the direct high voltage type inverter.

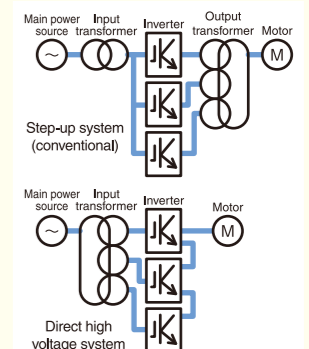

# PM Servo Drive PMD410

## PM Servo Drive PMD410



### PM Servo Drive that provides high-response performance at a high rate of power

- Is most suitable for machines where high torque and high response characteristics are required.
- Attains low inertia, compactness, and is light weight.
- Exhibits cleanliness and energy-saving thanks to the use of a motor-powered oil-hydraulic driving mechanism.

#### Specifications

Applicable motor	3.7~300kW (Note 1)
Max. instantaneous current	200V system : 49~771A 400V system : 99~1000A
Overload durability	150%、200%、250%、300%(Note 2)

Note 1: Please consult us regarding the upper capacity limits.  
Note 2: Please consult us regarding the overload durability time-based rating.

#### Control mode



#### Functions



### Major features:

#### High power rate and high-response performance

The capability assures 300% for maximum torque application, 1600Hz for current response, and 500Hz for speed response. This machine is most suitable for injection molding machines and press machines, where high power rate and high-response characteristics are required.

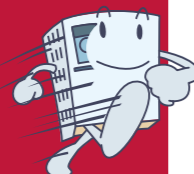

#### Attainment of low inertia, compactness, and lightweight design

For the PM servomotor, rare-metal permanent magnets are used in the rotor. Therefore, low inertia, compactness, and a lighter weight lightweight are attained. This feature supports the compactness of each machine.



#### Energy saving by motor-powered oil-hydraulic servo system

With the use of a motor-powered oil-hydraulic servo system, oil-hydraulic pumps, which were formerly operated continuously, can be omitted. This feature contributes greatly to environmental cleanliness. When the PM servo motor is of the IM type, no secondary copper loss is generated and stray load losses are greatly reduced. Therefore, there are outstanding energy savings.

#### Maximum output of 300kW

Machines of 3.7kW to 300kW are standardized into a series. Thus, product lineups in a wide capacity range are available. The application range of the motor-powered feature is widely extended from small to large machines.

### PM servomotor

#### Product configuration

The GORIKI Series is composed of the SPM (Surface Permanent Magnet) attached to the rotor surface and the IPM (Interior Permanent Magnet) where magnets are embedded inside the rotor core. According to applications, the R (Response) Series, the T (Torque) Series, and the S (Standard) Series are available. The R and T Series offer characteristics of low inertia and high torque, while the S Series offers a high revolving speed, while still securing a large capacity and a high torque.

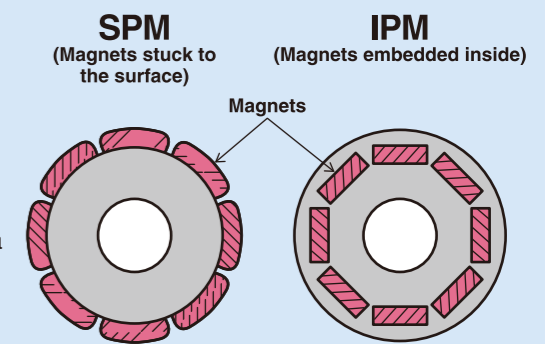

#### Product Series

Series (Construction)	High-response R Series (SPM)	High-torque T Series (SPM)	General-purpose S Series (IPM)
Rated output	3.7~75kW	45~400kW	3.7~400kW
Rated revolving speed	1500min <sup>-1</sup>	1000、750min <sup>-1</sup>	2000、1500min <sup>-1</sup>
Rated power rate	276~1790kW/s	1041~3426kW/s	72~723kW/s
Max. torque	1194N · m	10,186N · m	5093N · m
Rotor inertia J	0.0039~0.171kg · m <sup>2</sup>	0.168~7.57kg · m <sup>2</sup>	0.0051~8.97kg · m <sup>2</sup>

#### Custom-made models

According to customers' requirements, the PM servo drives can be customized, utilizing the features of easy shaping and machining for PM servomotors. Satisfying the required torque characteristics and obtaining an optimal construction according to the machines' specification, space-saving and lower cost can be secured for the machine as a whole.

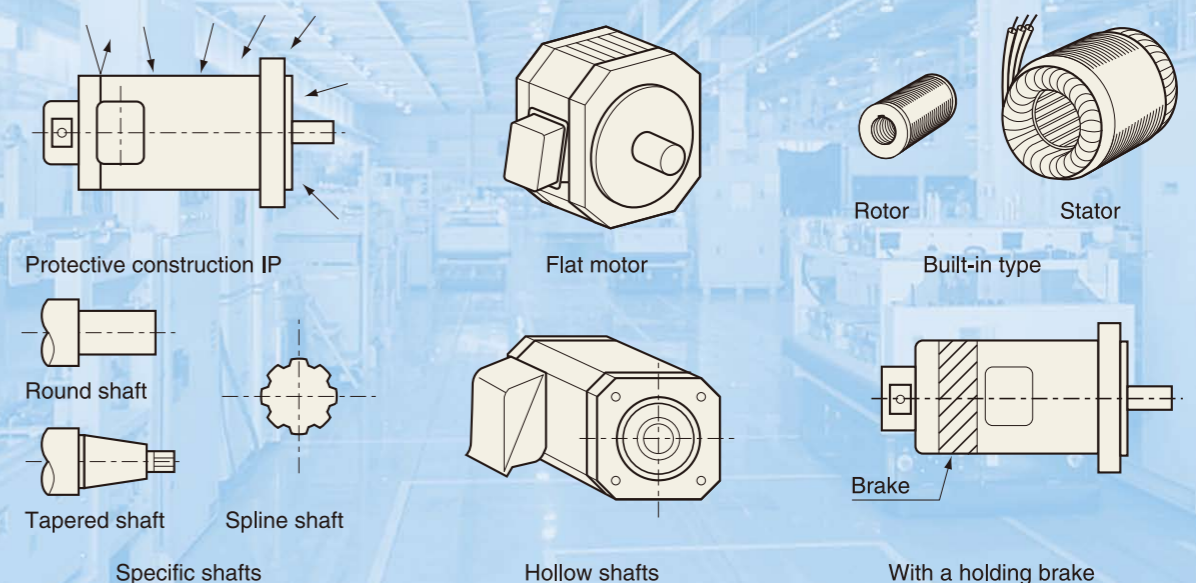

Inverter for fiber machines

# THYFREC VT630



## Exclusive inverters customized for fiber machines

- Optimal driving of a self-start type PM motor.
- Realization of high-accuracy control with an open loop.
- Full of exclusive functions for fiber machines.

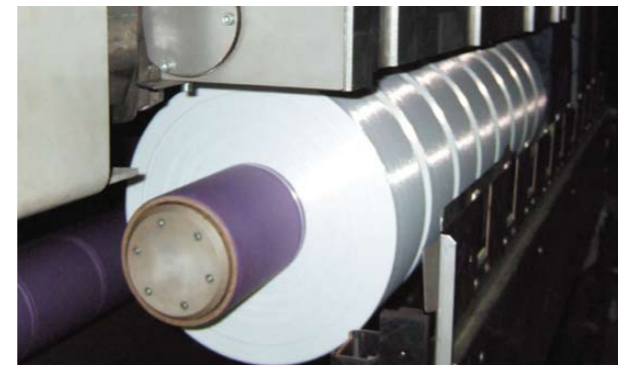

### Specifications

Scope of capacity	6.2~250kVA
Max. rated continuous current	200V system : 18~288A 400V system : 9~360A
Overload durability	150% 1 min.

## Major features:

### Optimal driving of a self-start type PM motor for fiber machines

Since it is possible to drive a self-start type PM motor, high-accuracy control can be performed with an open loop. Countermeasures against momentary voltage drop are sufficient. It is possible to utilize the regenerative energy from the load. Multiple inverters can be operated at the same speed (1 second max.).

### Standard machines provided with exclusive functions are needed for fiber machines.

Standard machines can provide exclusive functions needed for fiber machines, such as the starting of a PM motor from zero speed, traversing operation, low/high speed patterned operation, signal output from output frequency counter, and measures against momentary voltage drops.

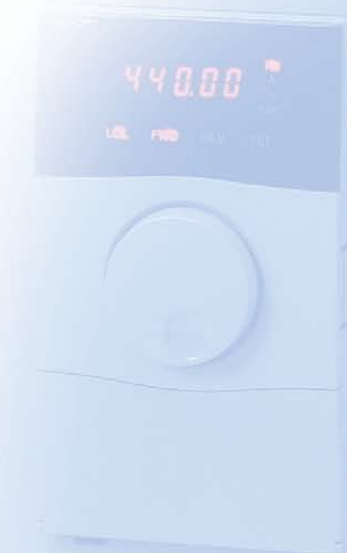
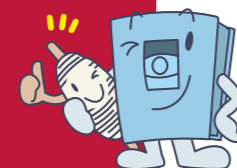

Slim inverters for fiber machines

# THYFREC VT630MS



## Slim inverters capable of speedy replacement and accommodation of multiple units

- Slim type where the draw-out system is adopted.
- Accommodation of a maximum of 15 units in one panel.
- Optimal driving of self-start type PM motors.
- Abundance of exclusive functions for fiber machines.



### Specifications

Scope of capacity	3.8~50kVA
Max. rated continuous current	200V system : 11~144A 400V system : 5.5~72A
Overload durability	150% 1 min.

## Major features:

### Speedy replacement of inverter units

Since the draw-out system is adopted for each unit, the inverter unit can be easily replaced by taking a one-touch action. If an inverter is out of order, it can be replaced promptly with a spare unit.

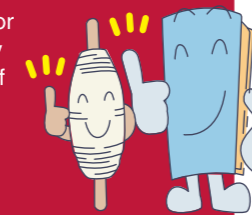

### Accommodation of multiple units in one panel thanks to the adoption of a slim design

A maximum of 15 units can be accommodated in one panel. Inverter units are standardized into two types; single size and double size. Efficient allocation of inverter units is possible in the accommodation panel. In addition, converter units are also available.





Thin inverters for elevators

# THYFREC VT800



## Thin inverters most suitable for machine-room-less elevators

- Thin and compact design with a depth of 90mm.
- Provided with a magnetic pole position sensory function available for PM motors.
- Elevator traveling control by a position learning function (Creepless floor-touch control).



### Specifications

Applicable motor	5.6~22kW
Rated input voltage	200~220V、380~440V
Max. rated continuous current/ Max. acceleration current	200V system : 26~94A/46~176A 400V system : 15~47A/27~88A

## Major features:

### Elevator traveling control is possible with the use of a position learning function.

The inverter detects the position of floor level so that elevator traveling control can be performed. By modal selection through serial communication (option) from the host controller, various controls are possible from the speed control in the selected mode to the creepless floor-touch control.

### The magnetic pole position can be identified for the PM motor.

In order to control a PM motor, it is necessary to detect the position of a magnetic pole in the PM motor. This inverter is provided with a function to locate the magnetic pole. Therefore, magnetic pole position sensors can be eliminated. PM motor control is possible with the use of an ordinary encoder (ABZ phase signal).

## Scope of application for elevator appliances

Scope of application is specified for the THYFREC VT800 and THYFREC VT240EL as well as the standard type (3T) and order type (5T) hoist machines.

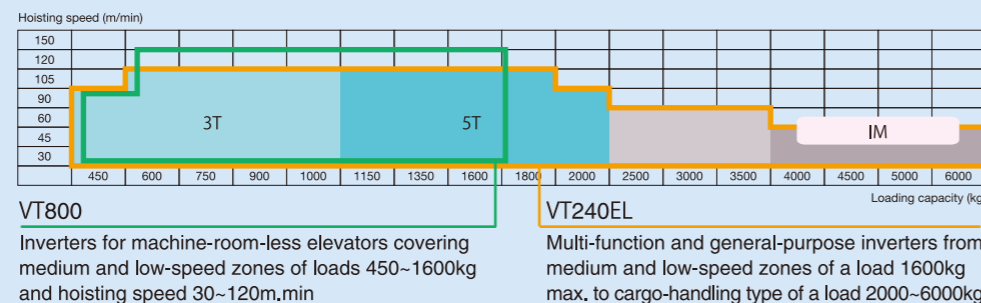

General-purpose inverters for elevators

# THYFREC VT240EL



## General-purpose inverters for elevators full of new features

- Provided with a rollback restraint function.
- Provided with a magnetic pole position sensory function available for PM motors.
- Provided with an auto-tuning function for motor constants (IM & PM motors).



### Specifications

Applicable motor	2.2~50kW
Rated input voltage	200~240V、380~480V
Max. rated continuous current/ Max. acceleration current	200V system : 11~193A/19~347A 400V system : 5.5~87A/9.9~156A

## Major features:

### Rollback restraint is possible without any information about loading.

For elevator control, accurate information about loading is indispensable. At the time of periodic inspection, adjustment of load sensors is indispensable. In order to compensate for errors in load information, a rollback restraint function is provided to the VT240EL. With this function, safety can be secured at the time of installation and adjustment of load sensors can be simplified. Auto-tuning of PM motor constants is possible. The use of auto-tuning function eliminates troublesome work such as motor constant setup. Even when existing motors are used, optimal tuning is possible.

### Auto-tuning of PM motor constants is possible.

The use of auto-tuning function eliminates troublesome work such as motor constant setup. Even when existing motors are used, optimal tuning is possible.

## PM motors for elevators

The hoisting PM motors (3T, 5T) to be installed at the lowest level of the elevator shaft and thin type hoist machines have been standardized into a product series. The hoist machines are installed in a clearance between the elevator car and the shaft wall.

	3T	5T	Thin type
Loading capacity (kg)	450~1000	1150~2000	450~1000
Elevator speed (m/min)	45~105		



### Major features:

- ① High-performance rare metal magnets are used.
- ② High torque and low-torque ripples are attained, providing for a comfortable ride.
- ③ Compactness and low-noise design are most suitable for machine-room-less elevators.

## Inverters for high-speed elevator

# THYFREC VT850H



### Specifications

Applicable motor	11~54kW
Rated input voltage	380~480V
Max. rated continuous current/ Max. acceleration current	62~75/ 130~160A

## Inverters for high-speed elevators

- Provided with a rollback restraint function.
- Control of elevator traveling by position learning function.
- Effect of energy saving attained by power regenerative function.
- Conformance to the Safety Standard IEC61508.

## Major features:

### This type of inverter covers a wide range of medium and high-speed ranges.

These inverters are applicable where the loading capacity is 1350~2000kg and the elevator speed is 120m/min ~ 240m/min. Thanks to an abundance of exclusive functions for elevators, riding comfort is outstanding.

### Provision of power regenerative converters

With the power regenerative function, regenerative energy from a motor is fed back to the power source side. This feature contributes to energy saving. Sinusoidal approximating PWM current control is performed to obtain sinusoidal input current waveforms. This feature greatly restrains the intrusion of harmonics into the power source.

### Elevator traveling control is possible with the use of a position learning function.

The inverter detects the position of floor level so that elevator traveling control can be performed. By modal selection through serial communication from the host controller, various controls are possible from the speed control in the selected mode to the creepless floor-touch control.

### Rollback restraint is possible without any information about loading.

For elevator control, accurate information about loading is indispensable. At the time of periodic inspection, adjustment of load sensors is indispensable. In order to compensate for errors in load information, a rollback restraint function is provided to the VT850H. With this function, safety can be secured at the time of installation and adjustment of load sensors can be simplified. Auto-tuning of PM motor constants is possible. The use of auto-tuning function eliminates troublesome work such as motor constant setup. Even when existing motors are used, optimal tuning is possible.

## PM motors for high-speed elevators

PM motors (13T, 15T) have been standardized into a product series where the loading capacity is 900~2000kg and the elevator speed is 120m/min ~ 240m/min.

	PM13T	PM15T
Loading capacity (kg)	900~1600	1800~2000
Elevator speed (m/min)	120~240	



### Major features:

- ① High-performance rare metal magnets are used.
- ② High torque and low-torque ripples are attained, providing for a comfortable ride.
- ③ Compactness and light weight are assured.

## IGBT Scherbius unit

# THYFREC CV700SB



### Specifications

Applicable motor	500~not more than 4000kW
Speed control range	60~98% (Starter circuit required)
Voltage and current	Secondary voltage : 1570V or below Secondary current : 250~2000A
Overload durability	120%, 1 min.
Efficiency and power factor	Unit efficiency : 96% or above, unit power factor : 95% or above

## Most suitable for energy-saving drive of wound-rotor type motors

- Most suitable for the speed control of wound-rotor type induction motors.
- Large effect of energy saving with high efficiency.
- Space saving.
- Measures have been taken against harmonics and there is no need for power factor improving equipment.

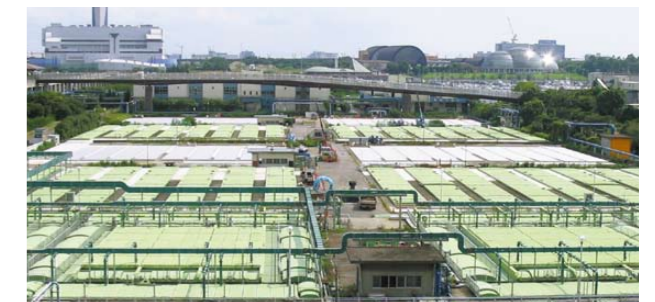

Sewage treatment plant

## Major features:

### No need for countermeasures against harmonics

The PWM type power regenerative inverters are used for sinusoidal wave approximating PWM control so that intrusion of harmonics into the source side can be greatly suppressed.

### High power factor

Unity power factor control is performed for the regenerated power; therefore, it is unnecessary to perform power factor improvements during Scherbius operation.

### Energy-saving and space-saving

Constitutive devices such as inverter transformers and power regenerative inverters are made compact. Since loss generation is minimal, high efficiency can be attained. Installation of equipment is easy because of the compact design.

### No need for measures taken against momentary voltage drop

Since IGBT devices are used, protection of converters is not required in the case of momentary voltage drop, while it was required where a conventional thyristor system was adopted.

## What is CV700SB?

The direct high-voltage type inverter, THYFREC VT710, is connected to the primary circuit of a motor, while the CV700SB is connected to the secondary circuit of a wound-rotor type motor. Motor energy is fed from the primary circuit and the amount of regenerated energy from the secondary circuit to the power source is controlled by the CV700SB to change the motor revolving speed.

For the CV700SB, only energy from the secondary circuit of the wound-rotor type motor is controlled; therefore, the amount of electrical energy to be handled can be minimized as compared with the VT710 where all energy in the primary circuit is controlled. For this reason, the unit efficiency of VT710 is superior to that of CV700SB, while the system efficiency of CV700SB is somewhat superior to the other.

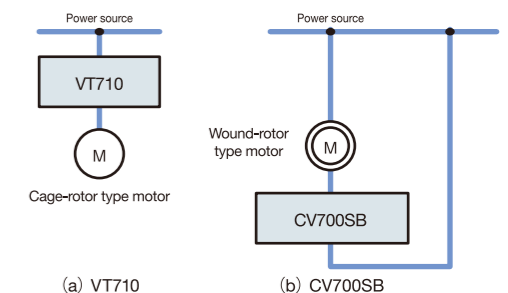

High-performance inverters for general industries

# THYFREC VT310



## High-performance models of vector control type inverters with sensors

- Attainment of high-speed response operation equivalent to servo drivers.
- Realizing high performance through the introduction of modern control theorem.

### Attainment of outstanding speed-control responses and high performance

Speed-control responses of 50Hz or above have been attained. By compensation with the use of load torque observers, speed observers, and inertia compensation functions, high-performance characteristics are secured. If an optional high-speed ACR linkage function is used, current-related command signals can be digitally exchanged between inverters so that load balance control for multiple motors can be performed.

#### Specifications

Applicable motor	1.5~550kW
Capacity range	200V system : 2.5~110kVA 400V system : 2.2~662kVA
Rated input voltage	200~230V、380~460V
Overload durability	150%, 1 min.

Thyristor Leonard

# THYL 300C



## All-digital type DC motor control unit

- Attainment of high-accuracy speed control with the use of an all-digital system.
- Provided with control functions covering a variety of applications.

### Wide range of speed control with high accuracy

With the all-digital control system, the control accuracy is kept within  $\pm 0.03\%$  and speed control of 200:1 is possible within the control range.

#### Specifications

Applicable motor	3.7~400kW
Rated output current	22~1150A
Rated input voltage	200~220V、400~440V
Overload durability	150%, 1 min.

## Inverter-related products

Power regenerative converters

# THYFREC CV240S



#### Specifications

Applicable motor	7.5~660kW
Rated DC output voltage	200V system : DC317.5~360V 400V system : DC635~720V
Overload durability	120% 1 min., 150% 1 min.

## Converters friendly to power source facilities and contributing to energy saving

- Restriction of harmonics intruding into the source side.
- High power factor control.
- Promotion of power regenerative operation.

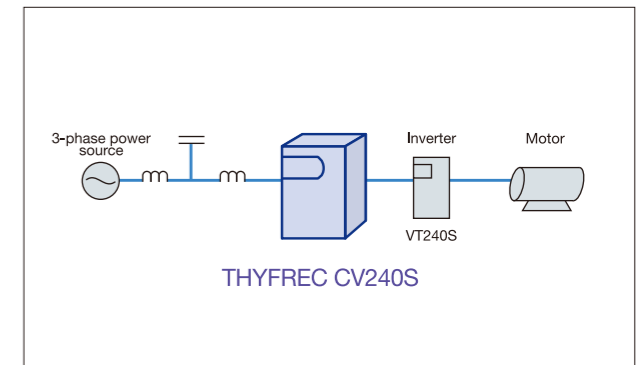

## Major features:

### Solutions to harmonics on power source side

Sinusoidal approximating PWM current control is performed to obtain sinusoidal input current waveforms. This feature greatly prevents the intrusion of harmonics into the power source. Combined with inverters, this equipment can be regarded as a self-excitation 3-phase bridge (K5=0) which characteristics conform to the "Harmonics Restraint Guidelines" issued by Ministry of Economy, Trade and Industry.

### Reduction of the source capacity by high power factor control

Since high power factor control is performed under the condition of the input power factor being almost unity, the capacity of power facilities can be reduced as compared with the result from standard type inverters.

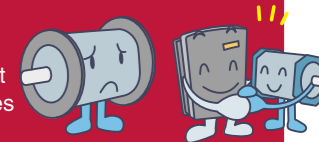

### Promotion of power regenerative operation

Due to the effect of the power regenerative function, this equipment can be used as a power regenerative converter that returns regenerated energy of a motor to the source side. When applied to frequent starting and continuous power regeneration, remarkable energy saving can be achieved. (100% continuous power regeneration is possible.)

### Establishment of common converter system

When a single converter unit is connected with multiple inverters, a multilateral system can be created.

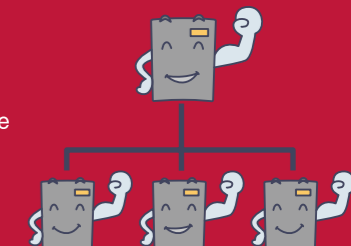

# Other products

Meidensha's motor-power-applied products full of advanced power-electronics technologies are actively used in the field of general industries such as iron and steel production lines, car manufacturing facilities, fiber machine facilities, and also in general lifelines such as elevators, fans, and pumps in buildings. In addition to variable speed drive systems, Meidensha manufactures a variety of products to be partially introduced below.

## Low-voltage/high-voltage motors

**Meiden motors are actively used with various industrial machines based on more than 100 years of abundant experience and sound technological skills.**

- Shock resistant motors, radiation resistant motors, underwater motors, and other specific motors are also available.
- There are many product lineups such as induction motors (cage-rotor, wound-rotor), models for explosion-proof specifications, brake-embedded types, etc.



Low-voltage specific motor



High-voltage motor

## PM drive system for electric vehicles (EV) and hybrid cars (HEV)

**Promotion of motor-powered vehicles with cutting-edge PM drive technologies**

- Compactness of equipment is secured with our advanced technologies for simulation and analysis.
- Reliability is verified at the company's outstanding evaluation/analysis facilities.
- Sensorless PM control is realized with the use of Meidensha's unique control algorithm.
- Meiden motors and inverters are adopted for the driving systems, the most essential parts, of the new generation electric vehicles "i-MiEV" manufactured and released by Mitsubishi Motors Corporation.



i-MiEV motor & inverter

## Dynamometer systems

**Always making full use of cutting-edge technologies, we offer high accuracy and high reliability testing systems.**

- A variety of dynamometer lineups are available for many applications.
- We have various achievement records in regard to testing computer systems. Any system most suitable for the customer's testing facilities can be designed and constructed.
- From dynamometers to buildings, air-conditioned interiors, and peripheral facilities, a total system on full-turnkey basis can be offered.

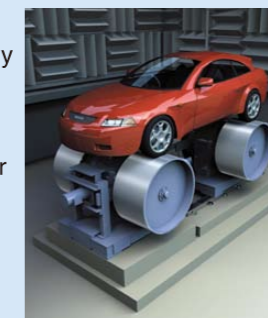

4WD chassis dynamometer



THYFREC VT330DY

## Motor controller for industrial vehicles AC400 Series

**High-efficiency forklift truck controller with low-loss FET**

- Applicable to IM/PM bilateral type motors
- Simplified vehicle cooling structure by attainment of high efficiency
- Improved degree of freedom in terms of vehicle mounting, thanks to dustproof/waterproof construction (IP54)
- Applicable to Rohs directive and REACH restrictions Specifications

Specifications

Type	AC400-S		AC400-L	
	Battery voltage	48V	72V&80V	48V
Max. current (3-min rating)	330Arms	250Arms	500Arms	370Arms
Control mode	Speed, torque control			
Applicable standard	Conforming to UL583			



※In addition to the products shown at the left, there are many product lineups for automated guided vehicles (AGV), applicable to a variety of physical distribution and transportation systems.

## Electric Double Layer Capacitor type momentary voltage drop compensator, MEIPOSS MCP

**Important facilities and data are protected against sudden momentary voltage drops.**

- High-speed changeover is possible between wide compensation time and a short time of 0.002 seconds or below.
- Since high efficiency (98% or above) is secured, a remarkable effect of energy saving can be expected.
- There are many lineups from low voltage (100kVA) to high voltage(20,000kVA).
- Voltage storage devices employ Meiden electric double layer capacitors (MEICAP).

Specifications

Type	Low voltage type	High voltage type
Capacity	100~200kVA	1000~20,000kVA
Compensation time	1~10sec.	
Voltage	210V(400V)	6.6kV(3.3kV)



Low voltage type 200kVA

# List of controls and functions

## List of control modes:

- V/f (Reduced torque)** Most suitable for square reduced torque loads such as fans and pumps where torque is small in a low-speed zone.
- V/f (Rated torque)** In a wide-ranged speed control operation, the generated torque of a motor can be kept constant. Applicable to extruders, conveyors, etc.
- Speed sensorless vector** Compared with V/f control, speed control and torque control can be performed with a higher accuracy even without speed sensors. Four-quadrant operation can be performed smoothly.
- Speed sensor-attached vector** It is possible to meet the requirements of high response, high accuracy, and wide control range. Most suitable for main drives of film lines, and iron and steel processing lines, as well as others.
- Sensorless PM** PM motors can be driven without speed sensors; therefore high-efficiency operation is possible.
- Sensor-attached PM** While a PM motor is driven, high efficiency operation can be performed. Not limited to the square reduced torque for fans and pumps, this control mode is applicable also to constant torque loads. Compared with induction motors, great energy saving can be attained.

## List of software functions

- Auto-tuning** Since the auto-tuning function is available, it is unnecessary to perform troublesome work such as motor constants setup. Even when existing motors are used, optimal tuning is possible regardless of their original manufacturers.
- High-efficiency operation** Output voltage is automatically reduced during operation at a light load so that motor's no-load losses can be suppressed in order to raise the combined efficiency.
- Interlocked ratio setting** In regard to the frequency setup value, this function is used for operational processing for gain and bias. It is preferably applied to operation in manufacturing lines where some speed differences have to be set up among multiple motors.
- Frequency jump** A motor can be operated, averting its mechanical resonance point at a specific frequency. This function is effective during V/f control.
- Drooping setting** While multiple mechanically connected motors are driven, it is possible to secure a load balance. This function is effective in vector control and PM motor control modes.
- Programmed frequency setting** Frequency setting can be fixed to several modes. This feature is convenient when setting values that do not need to be changed linearly. Once several kinds of necessary operation frequencies are set up in advance, operation can be performed by changing over the frequency of the sequence circuit from the outside.
- Multi-pump operation** Only one inverter unit can perform parallel running of multiple pumps.
- PID control** Using an analog input as a feedback value, a feedback loop can be established.
- Pattern operation** Automated operation is possible by making a changeover for frequency, operating direction, and time.
- Traversing operation** In a spinning system, this function permits an optimal patterned operation so that a yarn can be wound up uniformly.
- Simplified ASR operation** Even when the V/f control mode has been selected, an optional speed detection device can perform simplified speed control. Making simple adjustments, highly accurate speed control becomes possible.
- Spinning frame operation** Patterned operation for spinning is carried out. Unlike ordinary patterned operation, acceleration or deceleration commences toward the subsequent setting upon the attainment to the preset frequency. In the case of a service interruption, patterned operation is restarted after the recovery, based on data of frequency and time recorded at the time of stoppage.
- Character-S ramp** In order to relieve shocks at the time of acceleration and stoppage, speed changes can be shaped up smoothly.
- Momentary voltage drop restart** If a service interruption occurs to stop inverters, this function ensures that the revolving frequency of a free-running motor is searched for after the recovery from the service interruption. This occurs so that operation can be automatically restarted after making a connection with output frequency and voltage.
- Dynamic braking** During deceleration of a motor, it is driven with energy from the load side and electric energy is generated because the motor functions as a generator. This energy is consumed in a rheostat so that a brake force can be produced.
- DC braking** When a DC current is carried through a motor, the generated energy can be consumed in a form of heat and this can produce a brake force.
- Utility sync changeover** An operating motor can be switched over from inverters to a utility power supply, or vice versa, in a shockless mode.

# Meiden Variable Speed Products and Lifecycle Engineering

During the lifecycle of variable speed products relating to development, design, production, management, storage, and abolishment, Meidensha proposes the most optimal lifecycle engineering to meet the requirements of our customers.



### Concepts in facility introduction stage:

- Planning and formulation of new design
- Formulation of product design concept
- Examination of basic specifications
- Ordering
- Designing, manufacturing, and formation
- Completion
- Taking-over
- High reliability
- Environmental considerations
- Labor saving
- Energy saving
- Reduction of initial cost

### Examples of products and technologies

- Momentary voltage drop control system
- Energy saving system
- New energy system

### Concepts in stabilized operational stage:

- Start of management
- Steady management
- Efficient maintenance and control
- Optimal preservation plan
- Energy saving and running cost saving

### Examples of products and technologies

- Inspection supporting system
- Facility control system
- Remote maintenance

### Concepts in aging and updating stage:

- Life extending measure in facility aging stage
- Updating planning and formulation
- Rational maintenance and reduction of maintenance cost
- Optimal facility planning (judgment of life extension and updating)
- Updating planning
- Reuse and recycle

### Examples of products and technologies

- Maintenance where facility diagnostic techniques are introduced
- LCC-minimum facility planning
- Maintenance planning supporting system

Meidensha Corporation offers state-of-the-art systems to our customers. In all stages from the introduction of facilities inclusive of new development to facility updating, we deliver these systems that stem from the pursuit of economical rationality without sacrificing reliability. Based on an abundance of expertise relating to our variable speed systems, we continue to contribute to the improvement of facility performance, achievement of safe operation, and improvement of safety for our customers.

# Network

## Head Office

### MEIDENSHA CORPORATION

ThinkPark Tower, 2-1-1 Osaki, Shinagawa-ku,  
Tokyo 141-6029 Japan  
URL: <http://www.meidensha.co.jp>



### MEIDENSHA CORPORATION

ThinkPark Tower, 2-1-1, Osaki, Shinagawa-ku, Tokyo, 141-6029 Japan

[www.meidensha.co.jp](http://www.meidensha.co.jp)

#### Overseas Offices & Group Companies

## Production Bases



Meiden Numazu Works



Meiden Ohta Works



Meiden Nagoya Works



Kofu Meidensha Electric Mfg. Co., Ltd.



MEIDEN HANGZHOU DRIVE SYSTEMS CO., LTD.

## Overseas Offices and Group Companies

### China

DONGGUAN MEIDEN PACIFIC ELECTRICAL ENGINEERING CO., LTD.  
MEIDEN ZHENGZHOU ELECTRIC CO., LTD.  
MEIDEN SHANGHAI CO., LTD.  
MEIDEN HANGZHOU DRIVE SYSTEMS CO., LTD.  
SHANGHAI MEIDENSHA CHANGCHENG SWITCHGEAR CO., LTD

### Hong Kong

MEIDEN PACIFIC (CHINA) LTD.

### India

MEIDEN INDIA PVT. LTD.

### Indonesia

P.T. MEIDEN ENGINEERING INDONESIA

### Korea

MEIDEN KOREA CO., LTD.

### Malaysia

MEIDEN MALAYSIA SDN. BHD.  
MEIDEN METAL ENGINEERING SDN. BHD.

### Singapore

MEIDEN ASIA PTE. LTD.  
MEIDEN SINGAPORE PTE. LTD.

### Thailand

THAI MEIDENSHA CO., LTD.  
MEIDEN ELECTRIC (THAILAND) LTD.

### United Arab Emirates

MEIDENSHA CORPORATION DUBAI BRANCH

### The United Kingdom

MEIDEN EUROPE LTD.

### The United States

MEIDEN AMERICA, INC.  
MEIDEN TECHNICAL CENTER NORTH AMERICA LLC

### China

**DONGGUAN MEIDEN PACIFIC ELECTRICAL ENGINEERING CO., LTD.**  
No.1 Side Street 1 of DongFu Commercial Street, MoWu, WanJiang District,  
Dongguan City, GuangDong Province, P.C.523049 P.R.China  
Phone: 86-769-22285210 Facsimile: 86-769-22285250

**MEIDEN ZHENGZHOU ELECTRIC CO., LTD.**  
No.87 Hehuan Street, Zhengzhou Hi-Tech Industries Development Zone,  
Zhengzhou, Henan Province, P.C.450001, P.R.China  
Phone: 86-371-56971963 Facsimile: 86-371-56971981

**MEIDEN SHANGHAI CO., LTD.**  
Room 1806, Plaza 336, No. 336 Xizang Road (Middle)  
Huangpu-District, Shanghai, 200001, P.R. China  
Phone: 86-21-53062200 Facsimile: 86-21-63860058

**MEIDEN HANGZHOU DRIVE SYSTEMS CO., LTD.**  
No.168, Hongxing Road, Qiaonan District,  
Xiaoshan Economic & Technological Development Zone,  
Hangzhou, Zhejiang, P.C. 311231, P.R.China  
Phone: 86-571-83696808 Facsimile: 86-571-83696818

**SHANGHAI MEIDENSHA CHANGCHENG SWITCHGEAR CO., LTD.**  
No.885, Xingrong RD Industrial Zone, Jiading, Shanghai 201821, China  
Phone: 86-21-69169911 Facsimile: 86-21-69169922

### Hong Kong

**MEIDEN PACIFIC (CHINA) LTD.**  
Unit 01-02A, 16/F, Tower 1, Ever Gain Plaza,  
88 Container Port Road, Kwai Chung, N.T., Hong Kong  
Phone: 852-2503-2468 Facsimile: 852-2887-8046

### India

**MEIDEN INDIA PVT. LTD.**  
910, International Trade Tower, Nehru Place, New Delhi-110019, India  
Phone: 91-11-46539381 Facsimile: 91-11-46539385

### Indonesia

**P.T. MEIDEN ENGINEERING INDONESIA**  
20th Floor, Summitmas I, Jl. Jenderal Sudirman Kaveling 61-62  
P.O.BOX 6920/KBY/Summitmas I Jakarta Selatan 12190, Indonesia  
Phone: 62-21-520-0612 Facsimile: 62-21-520-0240

### Korea

**MEIDEN KOREA CO., LTD.**  
1404 DongHwa Bldg., 71, Yeouinaru-ro, Yeongdeungpo-gu,  
SEOUL 150-708 Rep. of KOREA  
Phone: 82-2-736-0232~3 Facsimile: 82-2-736-0234

### Malaysia

**MEIDEN MALAYSIA SDN. BHD.**  
Unit A-13-13A, Level 13, Menara UOA Bangsar 5,  
Jalan Bangsar Utama 1, 59000 Kuala Lumpur, Malaysia  
Phone: 60-3-22878188 Facsimile: 60-3-22879188

**MEIDEN METAL ENGINEERING SDN. BHD.**  
Lot 6, Peringkat 3, Kawasan Perindustrian Alor Gajah, 78000 Melaka, Malaysia  
Phone: 60-6-556-8790 Facsimile: 60-6-556-8795

### Singapore

**MEIDEN ASIA PTE. LTD.**  
5, Jalan Pesawat, Jurong Industrial Estate, Singapore 619363  
Phone: 65-6268-8222 Facsimile: 65-6264-4292

**MEIDEN SINGAPORE PTE. LTD.**  
5, Jalan Pesawat, Jurong Industrial Estate, Singapore 619363  
Phone: 65-6268-8222 Facsimile: 65-6264-4292

### Thailand

**THAI MEIDENSHA CO., LTD.**  
15th Floor, Rasa Tower II, 555 Phahol Yothin Road, Chatuchak,  
Chatuchak, Bangkok 10900, Thailand  
Phone: 66-2792-4200 Facsimile: 66-2792-4299

**MEIDEN ELECTRIC (THAILAND) LTD.**  
898 Moo 2, Bangpa-in Industrial Estate, Udomsornayuth Rd.,  
Klongjig, Bangpa-in, Ayutthaya 13160, Thailand  
Phone: 66-35-258258~262 Facsimile: 66-35-221388

### United Arab Emirates

**MEIDENSHA CORPORATION DUBAI BRANCH**  
Dubai Airport Free Zone, 6WA-606, P.O.Box 54919, Dibal,  
United Arab Emirates  
Phone: 971-4-2146692 Facsimile: 971-4-2146699

### The United Kingdom

**MEIDEN EUROPE LTD.**  
NYK Complex, Bradbourne Drive, Tilbrook, Milton Keynes MK7 8BN,  
England, U.K.  
Phone: 44-1908-276000 Facsimile: 44-1908-276010

### The United States

**MEIDEN AMERICA, INC.**  
15800 Centennial Drive, Northville Township, MI 48168, U.S.A.  
Phone: 1-734-656-1400 Facsimile: 1-734-459-1863

**MEIDEN TECHNICAL CENTER NORTH AMERICA LLC**  
15800 Centennial Drive, Northville Township, MI 48168, U.S.A.  
Phone: 1-734-656-1400 Facsimile: 1-734-459-1863

