



# PT. NIPPO MECHATRONICS INDONESIA (Corporate Outline)



**Ver. 2021**

**confidential**

# Corporate Outline-1.



Company Name : PT. NIPPO MECHATRONICS INDONESIA

Address : Bekasi International Industrial Estate Blok C4  
No.6-7 Desa Sukaresmi, Kec. Cikarang Selatan,  
Bekasi 17550

Directors : President Director (full time) Takahiro Zama  
Director (full time) Munenori Watanabe

Auditor : Komisaris Kanjo Nishitomi

Share Holder : NIPPO LTD. (78.6%) NIPPO(HK)LTD.(21.4%)

Foundation : 8/Jun/2012

Start Operation : 3/Jan/2013

Outstanding Share : 10,111 shares

Capital : USD 10,111,000

Employee : 234 employees (Oct-20 including 2 Japanese)  
Internship 17 Persons Total 251 Persons

# Corporate Outline-2.



- Land : 13,410m<sup>2</sup> ( 120m x 112m )
- Building : 6,687 m<sup>2</sup>
- Machine : 1. Injection Molding Machine  
(Horizontal 30t ~ 350 t ; Vertical 40 t )  
2. Teflon Coating Line
- Items : 1. Injection molding and assembly parts for automotive  
2. Teflon coating for Industrial parts
- Quality : ISO 9001:2015 25/Nov/2021  
ISO 14001:2015 25/Nov/2021
- Customers :Automotive & Motorcycle maker , etc.

# Location

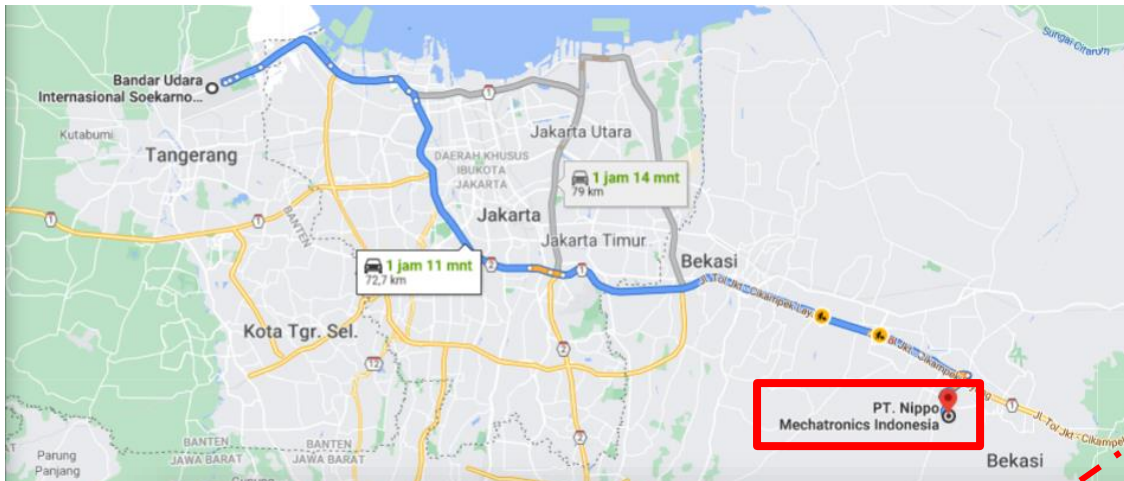

**±1.5 hours from airport (73km)**  
**±1 hour from Jakarta (45km)**  
**※if there is no traffic jam**



**PT. Nippo Mechatronics Indonesia**

4,0 ★★★★★ (19)  
Pabrik Plastik

📍 Blok C4 No., Jl. Inti II No.6-7, Sukaresmi, Cikarang Sel., Bekasi, Jawa Barat 17530

# Number of machines and types



30t 40t(V) 50t 75t 100t 130t 220t 350t

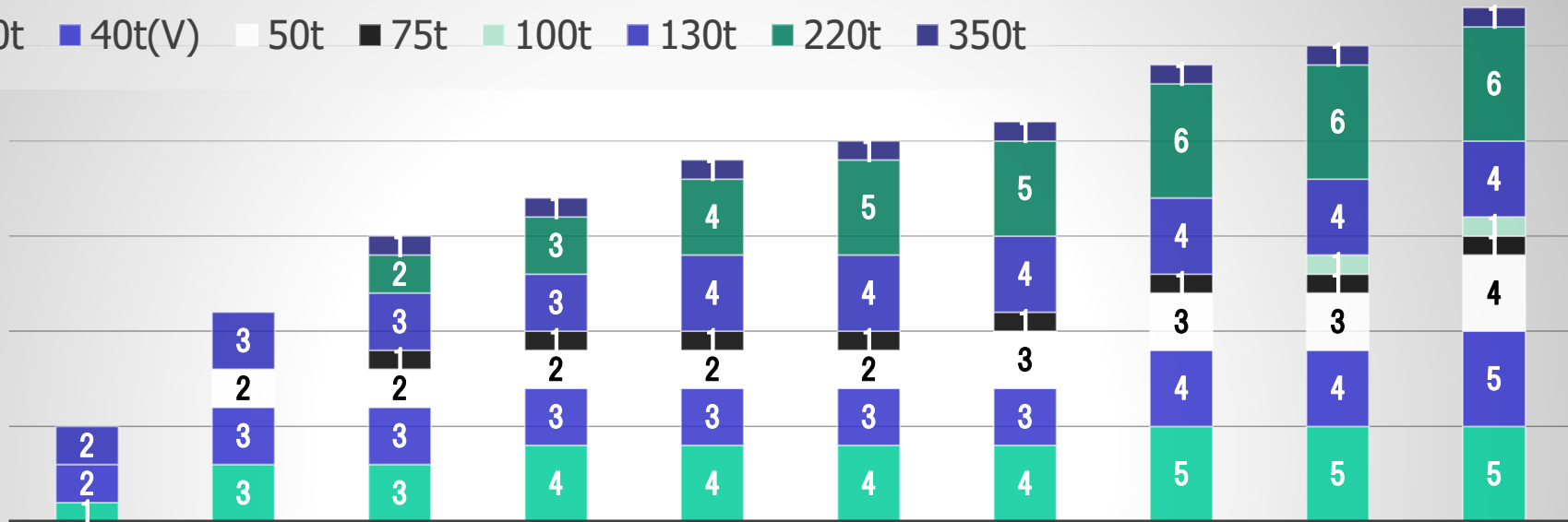

	2012	2013	2014	2015	2016	2017	2018	2019	2020	2021
30t	1	3	3	4	4	4	4	5	5	5
40t(V)	2	3	3	3	3	3	3	4	4	5
50t		2	2	2	2	2	3	3	3	4
75t			1	1	1	1	1	1	1	1
100t									1	1
130t	2	3	3	3	4	4	4	4	4	4
220t			2	3	4	5	5	6	6	6
350t			1	1	1	1	1	1	1	1
<b>TOTAL</b>	<b>5</b>	<b>11</b>	<b>15</b>	<b>17</b>	<b>19</b>	<b>20</b>	<b>21</b>	<b>24</b>	<b>25</b>	<b>27</b>



# Factory Layout

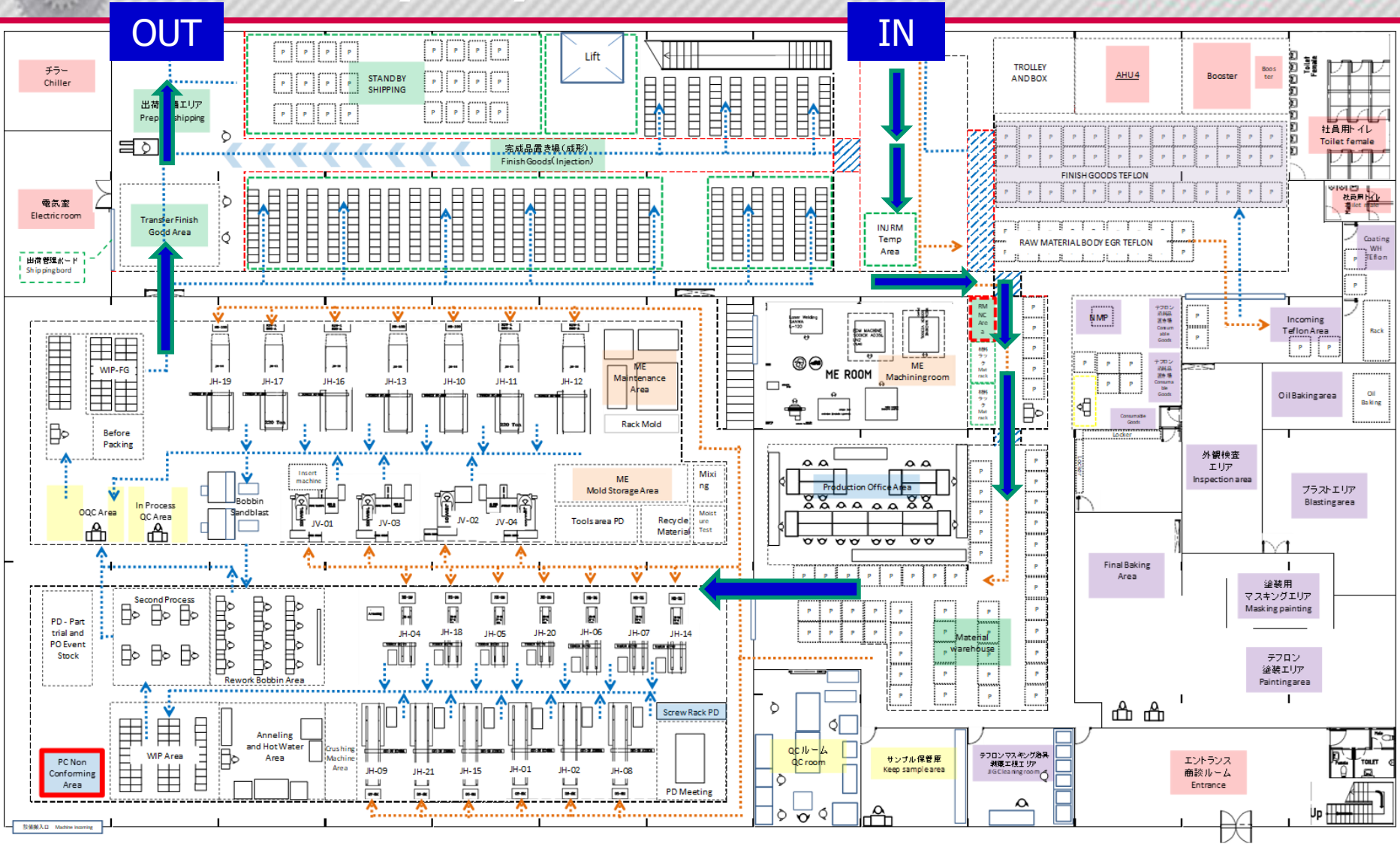

- ←····· 製品動線 Traffic line of parts
      フォークリフト走行ゾーン Road for Fork lift
   共通エリア General area
   QCエリア QC area
   PD2エリア PD2 area
- ←····· 材料動線 Traffic line of material
      作業者用通路 Road for persons
   PD管轄エリア PD area
   BCエリア BC area
   MEエリア ME area

# Machine Tools and Equipment



**NC MILLING**

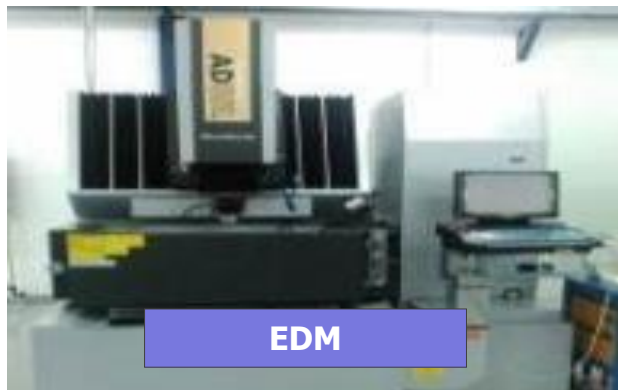

**EDM**



**WEDM**



**CYLINDRICAL GRINDER**



**LASER WELDING**



**GRINDER**



**ULTRASONIC METAL MOLD CLEANING**



**DRILLING EDM**



**LATHE CENTER**

# Measurement Equipment



CMM

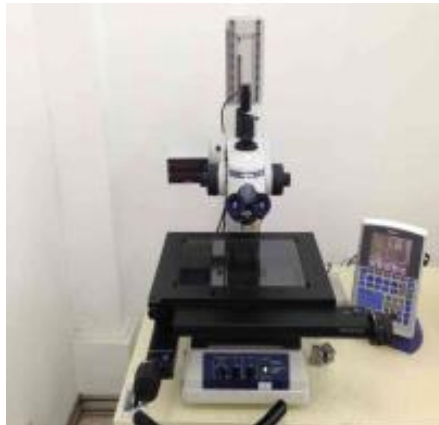

Tool Microscope

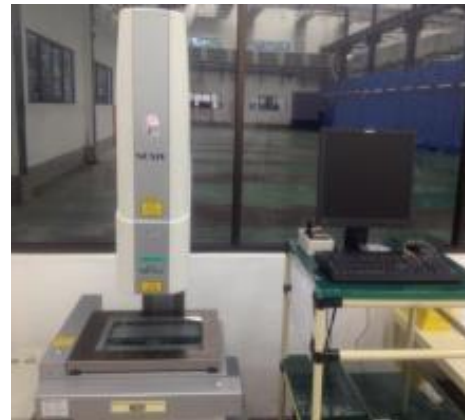

Vision measuring instrument



Load Tester



Contour Machine

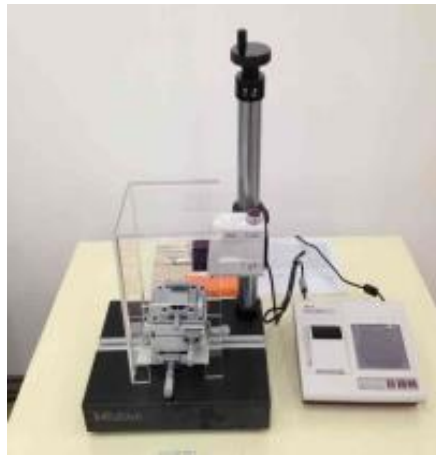

Surf Tester

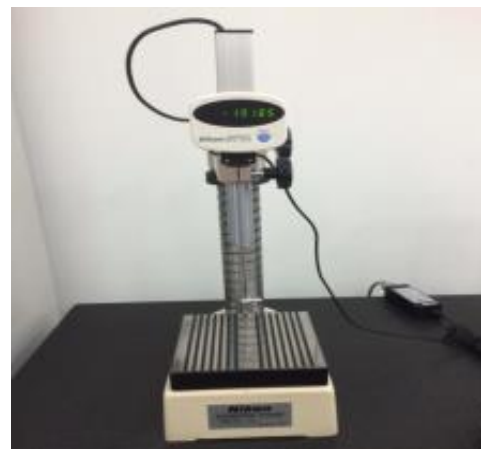

Digital Height



Vision measuring instrument



# Production item



Electric Control Part Engine



Fuel Supply Parts

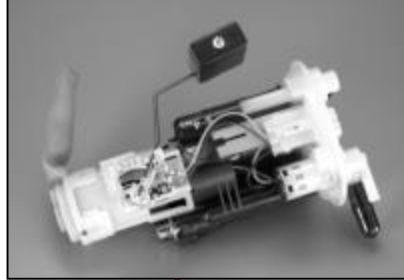

Electrical Component



Power Train Parts For Engine

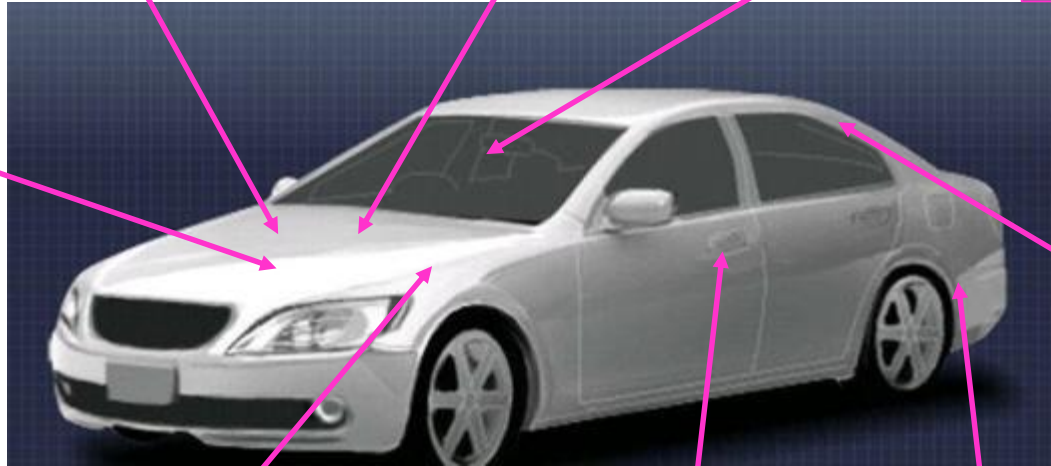

Vision Equipment Parts



Driving Safety Part



Door Part for Automotive



Emission Control System



# Production item



Fuel Supply Parts

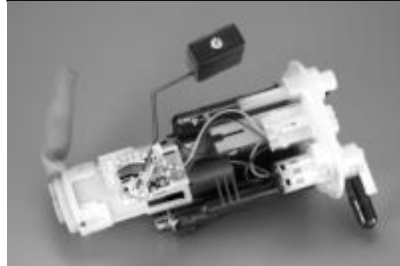

Vision Equipment Parts

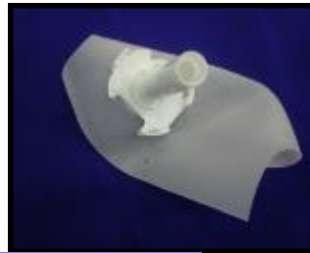

Fuel Pump Module Parts For ICE



Parts for Wiper



Fuel Pump Module Parts For ICE



SIFS Fuel Pump Module Parts For ICE

# Production item



Driving Safety Parts



Electrical Component



Shift Lever Assy



Part For HVAC

# Production item

## Emission Control System



Charcoal Canister



Cover for Charcoal Canister



Charcoal Canister

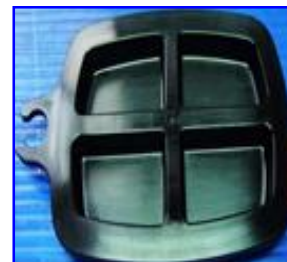

Cover for Charcoal Canister



# Production item

## Power Slide Door System Parts



## Power Slide Door Unit

# Production item

Door Part for Automotive



Part for Door Lock



Part for Door Handle

# Production item

## Motor Cycle



Fuel Supply Parts



ECU for Fuel Injection



Stepping Motor for ISC

# Customer List



PT. AISIN INDONESIA

PT. AISIN INDONESIA AUTOMOTIVE

PT. ADVICS MANUFACTURING INDONESIA

PT. AISAN NASMOCO INDUSTRI

PT. CHEMCO HARAPAN NUSANTARA

PT. DENSO INDONESIA

PT. DENSO MANUFACTURING INDONESIA

DENSO MANUFACTURING NORTH CAROLINA, INC

DENSO MANUFACTURING TIANJIN MOTOR CO.,LTD.

PT. KEIHIN INDONESIA

PT. MIKUNI INDONESIA

PT. MTAT-INDONESIA

PT. MITSUI KIZOKU ACT INDONESIA

PT. NOK INDONESIA





**THANK YOU**